

NAT1000X20RXX SMT Non-Isolated Point-of-Load Converters 8.5V – 18V input, 0.75V -5.5V 20A output

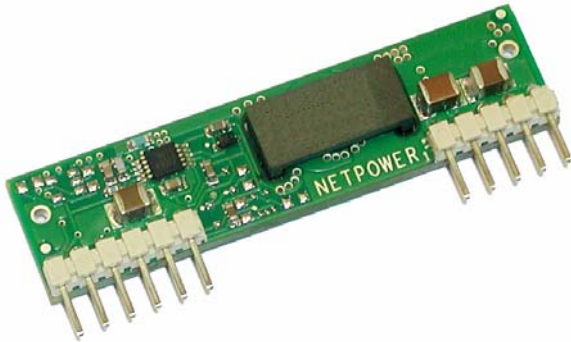

DOSA Compatible

RoHS Compliant Parts Available

Features

- High efficiency, 91% (12Vin, 3.3Vout@20A)
- Excellent thermal performance
- High output current: 20A
- Wide input-voltage range: 8.5V - 18V
- Wide output-voltage range: 0.75V to 5.5V
- Monotonic start-up into pre-biased load
- Output trim, Remote sense
- Switching frequency synchronization
- Remote enable control
- Small footprint: 2''x0.25''x0.5''
- All components meet UL 94V0

Applications

- Intermediate bus architecture
- Telecom, datacom, networking equipment
- Electronic data processing, servers
- Distributed power architectures

Options

- Baseplate
- Negative/Positive enable logic
- Output over-voltage protection
- Output voltage tracking/Sequence
- Various lead lengths

This *NAT Series* non-isolated point-of-load (POL) dc-dc converters deliver up to 20A of current in industry-standard SIP packages with high efficiency and unparalleled thermal performance. The *NAT* converters provide competitive cost, high performance, high reliability and quality, and flexibility of use in a wide range of applications. The open frame design with integrated magnetics has a small footprint (2''x0.25''), achieving industry-leading power density and enhanced airflow for nearby components. As a benefit of the high efficiency and resulting superior thermal performance, these converters can provide high output currents in challenging environments with simple thermal management. These converters provide input under-voltage lockout, remote sense, wide output voltage trim, overload and short circuit protection and over-temperature shutdown as standard features. NetPower also offers optional output over-voltage protection which provides increased protection and system reliability in practical applications. The output voltage sequence/tracking features allows the output voltage to track an external signal during startup and shutdown in systems with sensitive powering timing requirements. To further improve thermal performance in extreme environments, NetPower offers a baseplate option for these POL converters. The baseplate option also allows the converters to be used in conduction-cooled systems.

NAT series converters are excellent choices for today's densely packed systems with limited board space. The wide input and output voltage ranges and user-friendly features are ideal for telecom, datacom, wireless networks, computing, industrial, and automotive applications.

† UL is a registered trademark of Underwriters Laboratory Inc.

Absolute Maximum Ratings

Excessive stresses over these absolute maximum ratings can cause permanent damage to the converter. Also, exposure to absolute maximum ratings for extended periods of time can adversely affect the reliability of the converter. Operation should be limited to the conditions outlined under the Electrical Specification Section.

Parameter	Symbol	Min	Max	Unit
Input Voltage (continuous)	V_i	-0.5	22	Vdc
Operating Ambient Temperature (See Thermal Consideration section)	T_o	-40	85*	°C
Storage Temperature	T_{stg}	-55	125	°C

Electrical Specifications

These specifications are valid over the converter's full range of input voltage, resistive load, and temperature unless noted otherwise.

Input Specifications

Parameter	Symbol	Min	Typ	Max	Unit
Input Voltage	V_i	8.5	12	18	Vdc
Input Current	$I_{i,max}$	-	-	10	A
Quiescent Input Current ($V_{in} = 12$, $V_o = 3.3V$)	$I_{i,Qsnt}$	-	120	200	mA
Standby Input Current	$I_{i,standby}$	-	2	-	mA
Inrush Transient	I^2t	-	-	0.5	A ² s
Input Reflected-ripple Current, Peak-to-peak (5 Hz to 20 MHz, 1 μ H source impedance)	-	-	20	-	mAp-p
Input Ripple Rejection (120 Hz)	-	-	30	-	dB
Input Turn-on Voltage Threshold	-	-	8.3	-	V

Output Specifications

Parameter	Symbol	Min	Typ	Max	Unit
Output Voltage Set Point Tolerance ($V_i = 12$ V; $I_o = I_{o,max}$; $T_a = 25^\circ\text{C}$)	-	-2.0	-	2.0	%
Output Voltage Set Point Tolerance (over all conditions)	-	-2.5	-	3.50	%
Output Regulation:					
Line Regulation ($V_i = 8.5V$ to $18V$, $I_o = 1/2$ of load)	-	-	0.2	-	% V_o
Load Regulation ($I_o = I_{o,min}$ to $I_{o,max}$, $V_i = 12V$)	-	-	0.3	-	% V_o
Temperature ($T_a = -40^\circ\text{C}$ to 85°C)	-	-	0.2	-	% V_o
Output Ripple and Noise Voltage (5 Hz to 20 MHz bandwidth, $V_{in} = 12V$)	Peak-to-peak -	-	1.5	-	% V_o
	RMS	-	-	1	% V_o
External Load Capacitance	-	-	-	5,000	μ F
Output Current	I_o	0	-	20	A
Output Current-limit Trip Point	$I_{o,cli}$	-	200	-	% I_o
Output Short-circuit Current, hiccup mode	-	-	3	-	A
Switching frequency	-	270	300	330	kHz
Output Over Voltage trip point (optional, hiccup mode)	-	115	125	135	% V_o
Voltage Tracking/Sequencing Slew Rate – Power UP	-	-	-	2	V/ms
Voltage Tracking/Sequencing Slew Rate – Power down	-	-	-	1	V/ms

*For operation above 85°C ambient temperature, please consult NetPower for derating guidance

**With heat plate. $I_{o,max} = 15A$ without heat plate.

Output Specifications (continued)

Parameter	Symbol	Min	Typ	Max	Unit
Efficiency (Vi = 12V; Io = Iomax, TA = 25°C)	Vo = 0.75V η		73		%
	Vo = 1V η		78		%
	Vo = 1.2V η		81		%
	Vo = 1.5V η		84		%
	Vo = 1.8V η		85.5		%
	Vo = 2.5V η		88.5		%
	Vo = 3.3V η		91		%
	Vo = 5V η		93		%
Consult factory for Vo>5.5V					
Dynamic Response (Vi = 12V; Ta = 25°C; Load transient 0.5A/μs)					
Load step from 50% to 100% of full load:					
Peak deviation			200		mV
Settling time (to 10% band of Vo deviation)			70		μs
Load step from 100% to 50% of full load:					
Peak deviation			200		mV
Settling time (to 10% band of Vo deviation)			70		μs

General Specifications

Parameter	Symbol	Min	Typ	Max	Unit
Remote Enable					
Negative Logic:					
Logic Low – Module On	-	-	-	-	-
Logic High – Module Off					
Positive Logic:					
Logic High – Module On	-	-	-	-	-
Logic Low – Module Off					
Logic Low:					
ION/OFF = 1.0mA	VON/OFF	0	-	0.5	V
VON/OFF = 0.0V	ION/OFF	-	-	1.0	mA
Logic High:					
ION/OFF = 0.0μA	VON/OFF	-	-	15	V
Leakage Current	ION/OFF	-	-	50	μA
Over-temperature Protection	To	-	120	-	°C
Turn-on Time (Io = full load, Vo within 1% of setpoint)	-	-	6	-	ms
Calculated MTBF (Bellcore TR-332, 40°C, full load)			> 5		10 ⁶ -hour

Characteristic Curves

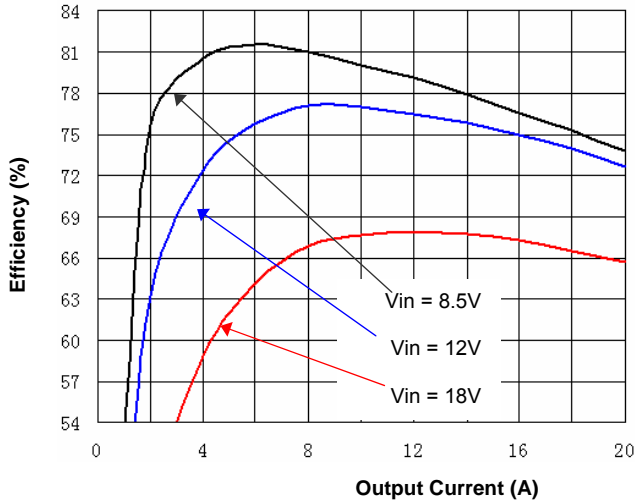

Figure 1(a). Efficiency vs. Load Current (25°C, 0.75V output)

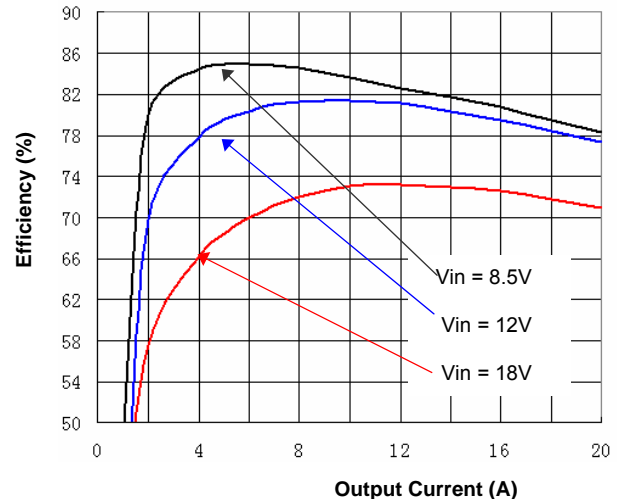

Figure 1(b). Efficiency vs. Load Current (25°C, 1.0V output)

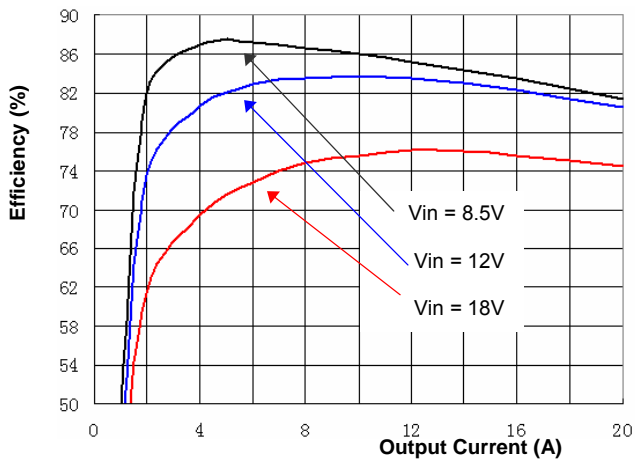

Figure 1(c). Efficiency vs. Load Current (25°C, 1.2V output)

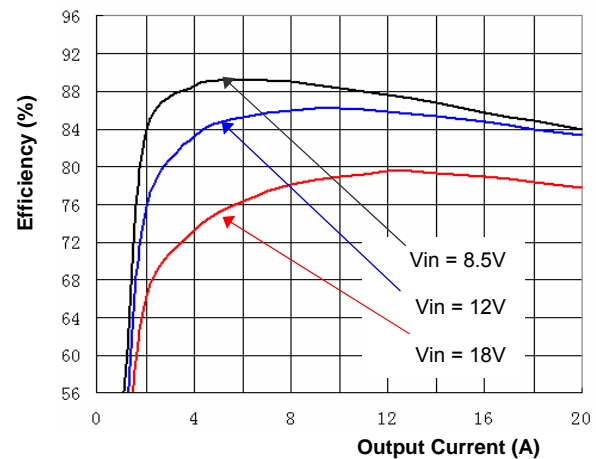

Figure 1(d). Efficiency vs. Load Current (25°C, 1.5V output)

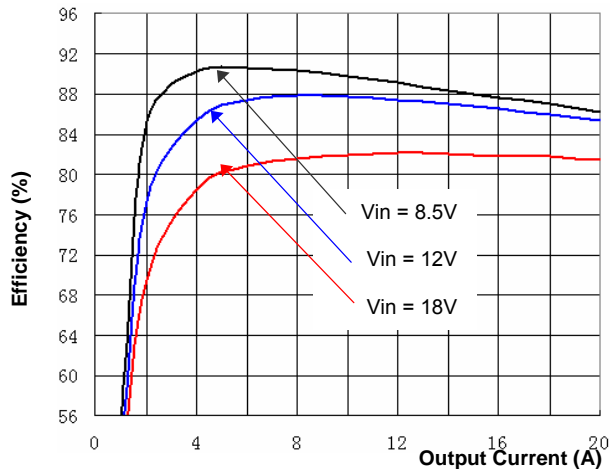

Figure 1(e). Efficiency vs. Load Current (25°C, 1.8V output)

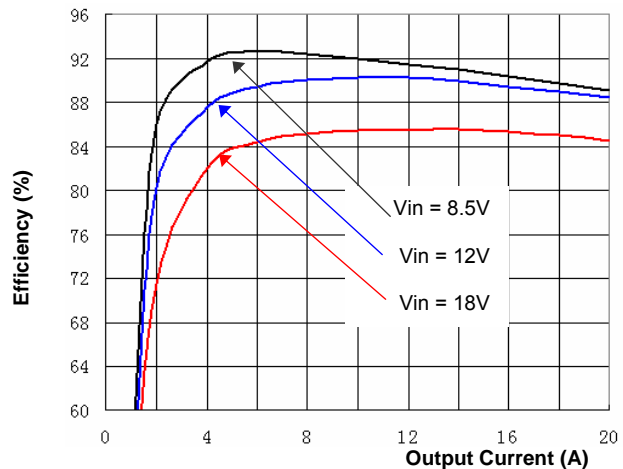

Figure 1(f). Efficiency vs. Load Current (25°C, 2.5V output)

Characteristic Curves

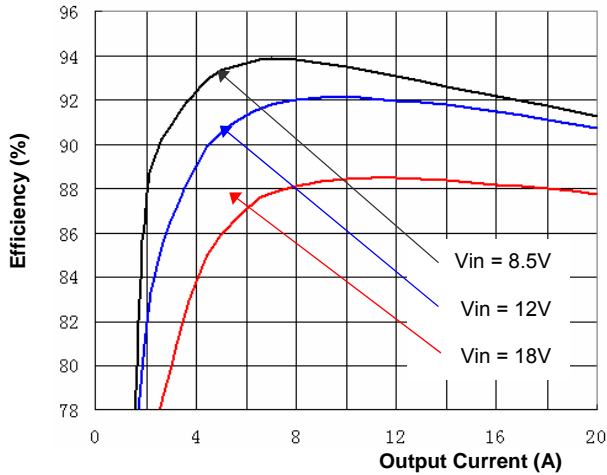

Figure 1(g). Efficiency vs. Load Current (25°C, 3.3V output)

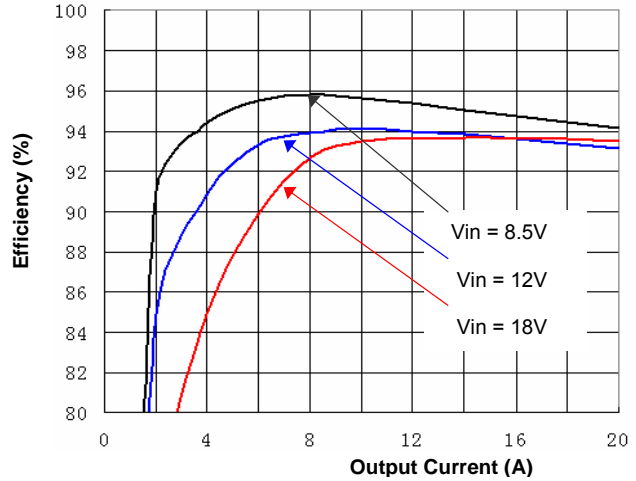

Figure 1(h). Efficiency vs. Load Current (25°C, 5V output)

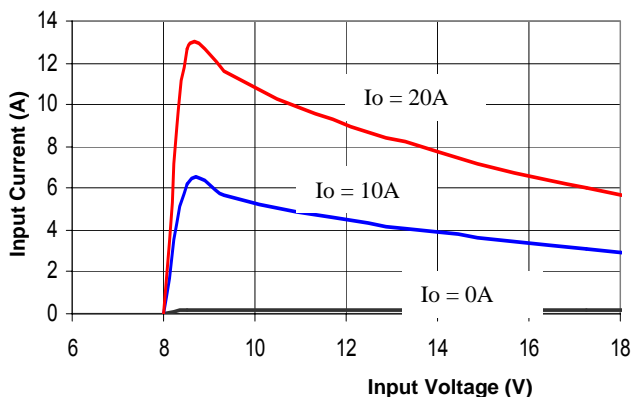

Figure 2. Input Characteristic (5V output)

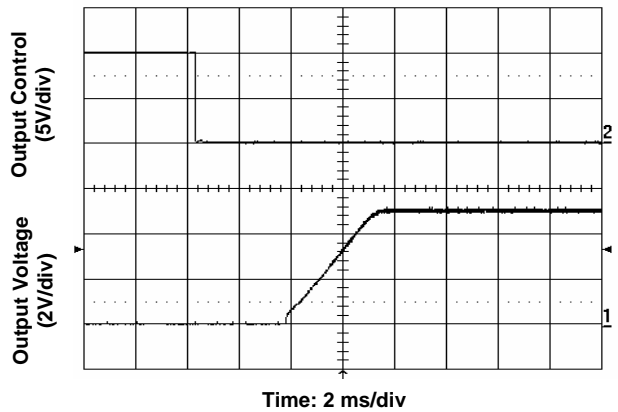

Figure 3. Start-Up from Enable Control Input voltage 12V, Output current 0A

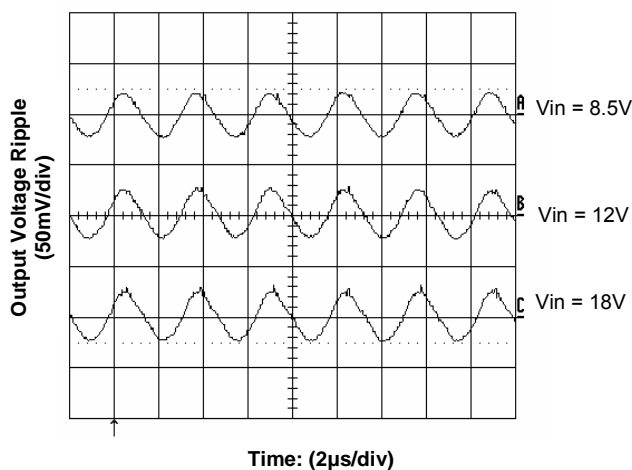

Figure 4. Output Ripple Voltage at 2.5V, 20A Output

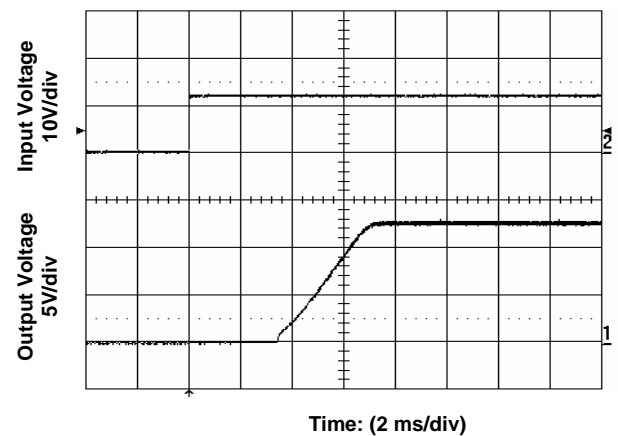

Figure 5. Start-Up from Application of Input Voltage Input voltage 12V, Output current 0A

Characteristic Curves

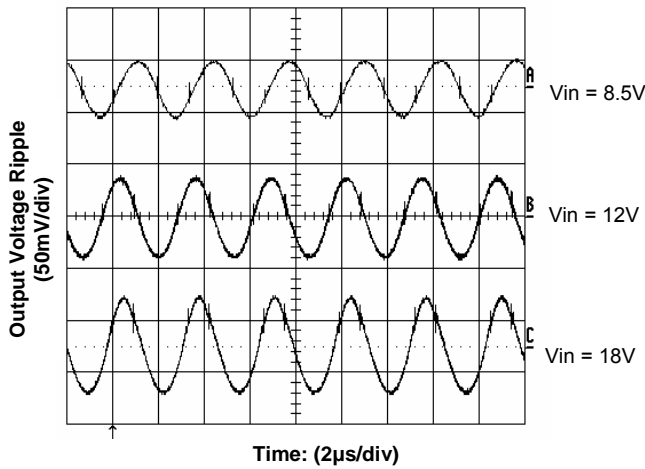

Figure 6. Output Ripple Voltage at 5V, 20A Output

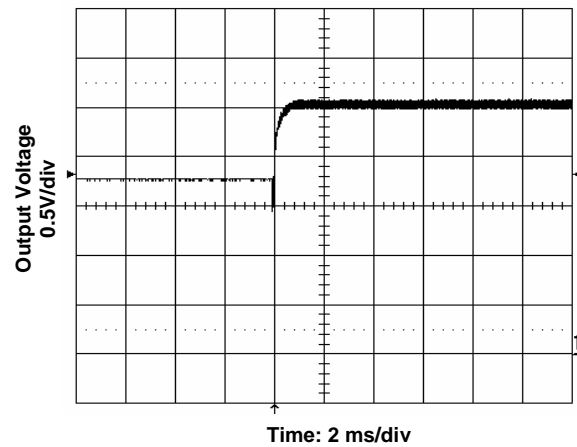

Figure 7. Start-Up with Prebias Input voltage 12V, Output current 0A, Output voltage 2.5V, Prebias 1.8V

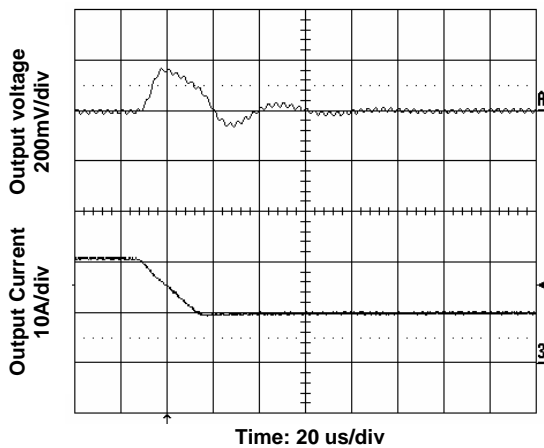

Figure 8. Transient Load Response. Input voltage 12V, Output current 20A->10A, Slew rate 0.5A/µs.

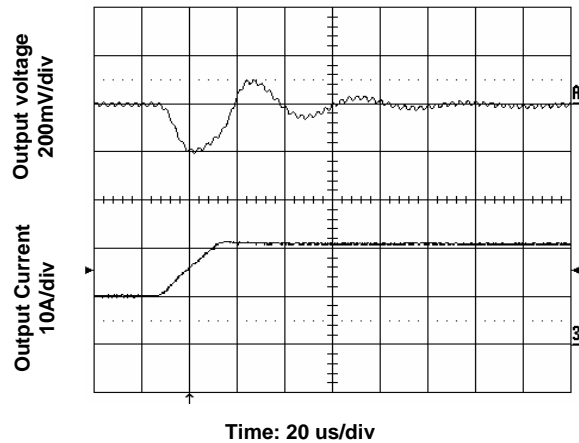

Figure 9. Transient Load Response. Input voltage 12V, Output current 10A -> 20A, Slew rate 0.5A/µs.

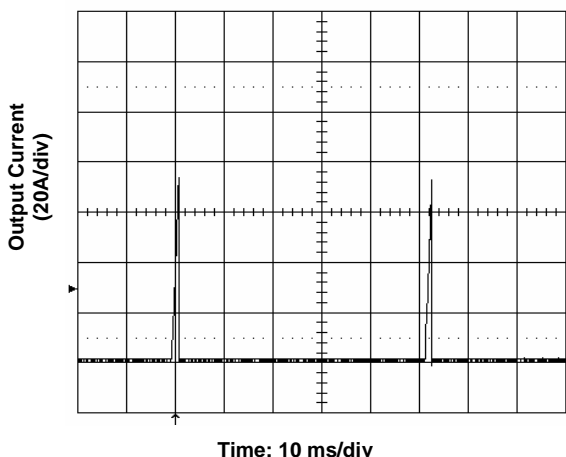

Figure 10. Short Circuit Current. Vin = 12V

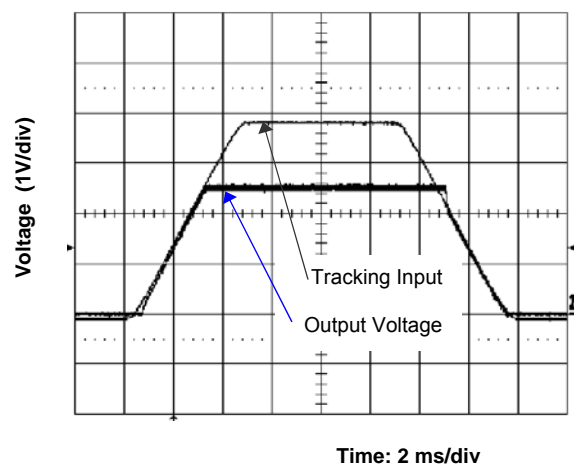

Figure 11. Voltage Tracking/Sequencing (with tracking option)
Vin = 12V, Vo = 2.5V, Io = 0A

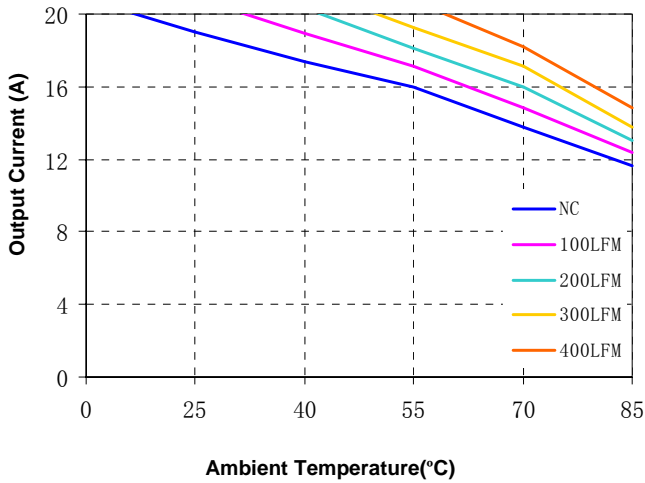

Figure 12(a). Current Derating Curve for 1V Output (Vin = 12V open frame)

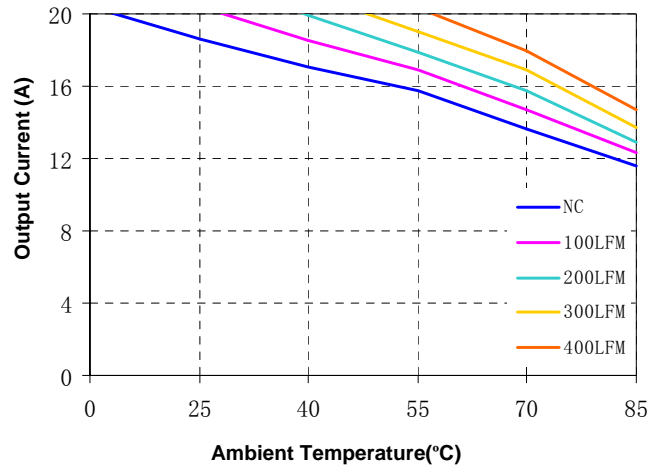

Figure 12(b). Current Derating Curve for 1.5V Output (Vin = 12V open frame)

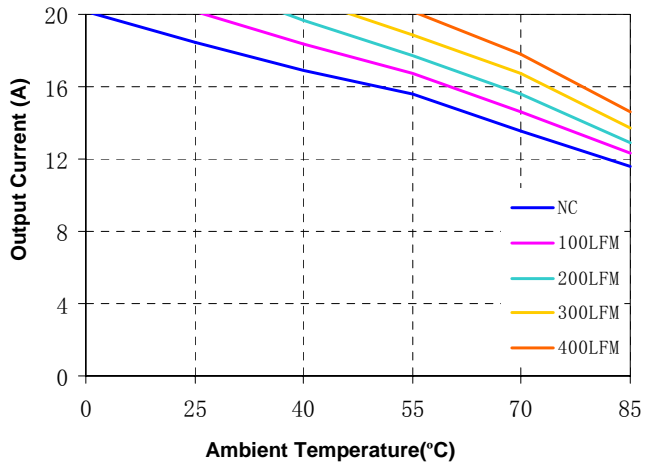

Figure 12(c). Current Derating Curve for 1.8V Output (Vin = 12V open frame)

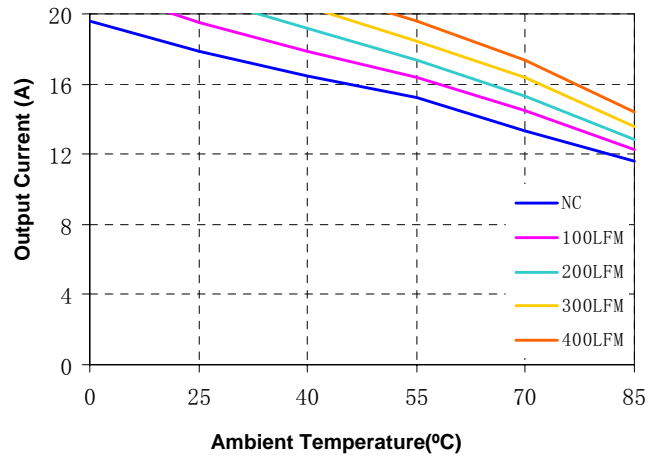

Figure 12(d). Current Derating Curve for 2.5V Output (Vin = 12V open frame)

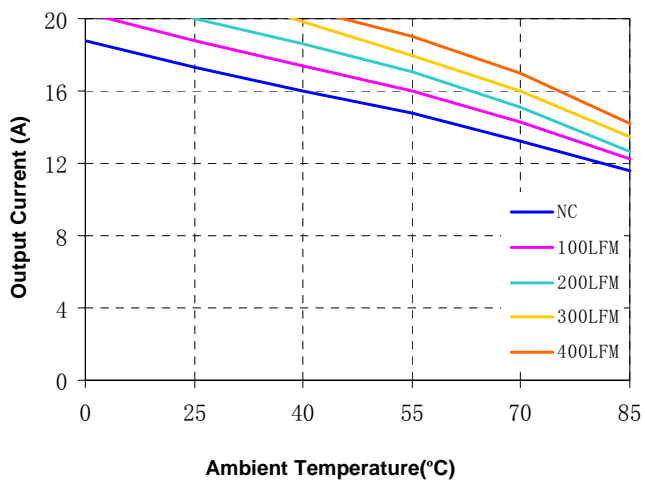

Figure 12(e). Current Derating Curve for 3.3V Output (Vin = 12V open frame)

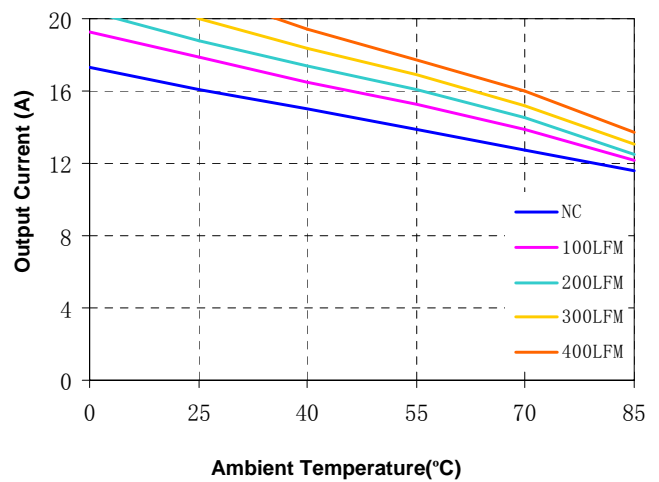

Figure 12(f). Current Derating Curve for 5V Output (Vin = 12V open frame)

Feature Descriptions

Remote ON/OFF

The converter can be turned on and off by changing the voltage or resistance between the ON/OFF pin and GND. The NAT converters can be ordered with factory selectable positive logic or negative enabling logic.

For the negative control logic, the converter is ON when the ON/OFF pin is at a logic low level, and OFF when the ON/OFF pin is at a logic high level. With positive control logic, the converter is ON when the ON/OFF pin is at a logic high level and OFF when the ON/OFF pin is at a logic low level. The converter is ON no matter what control logic is when ON/OFF pin is left open (unconnected).

Figure 13 is the recommended ON/Off control circuit for positive logic modules, while Figure 14 is for negative logic modules. Recommended value of the pull up resistor $R_{pull-up}$ is 50K. The maximum allowable leakage current from this pin at logic-high level is 20 μ A.

The logic-low level is from 0V to 0.5V, and the maximum switch current during logic low is 2mA. The external switch must be capable of maintaining a logic-low level while sinking this current.

Remote SENSE

The remote SENSE pin is used to sense voltage at the load point to accurately regulate the load voltage and eliminate the impact of the voltage drop in the power distribution path.

The SENSE pin should be connected to the point where regulation is desired. The voltage difference between the output pins must not exceed the operating range of this converter shown in the specification table.

When remote sense is not used, the SENSE pin can be connected to the positive output terminals. If the SENSE pins are left floating, the converter will deliver an output voltage slightly higher than its specified typical output voltage. The OVP (output over-voltage protection) circuit senses the voltage across the output pins, so the total voltage rise should not exceed the minimum OVP setpoint given in the

Specifications Table in operation.

Because the converter does not have remote sense connection for GND, it is important to make sure that the connection resistance and voltage drop between GND pin and the load is small.

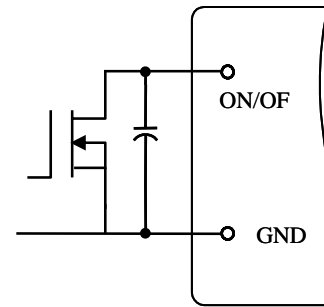

Figure 13 Circuit for Positive Logic Control

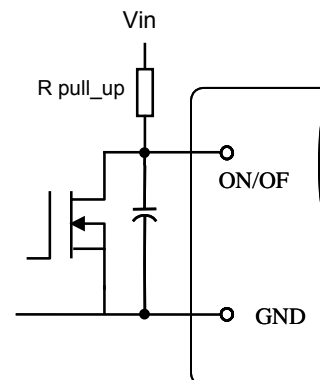

Figure 14 Circuit for Negative Logic Control



Output Voltage Programming and Adjustment

This series of converters are available with both variable output and fixed output voltages. The variable output voltage model's output voltage is preset to 0.7525V, and can be trimmed up to 5.5V using an external trim resistor. With a trim resistor, the output voltage of fixed output models can only be adjusted higher than the nominal output voltage. To trim the voltage lower than the nominal voltage, an external voltage higher than the nominal voltage has to be applied to the Trim pin. Output voltages higher than 5.5V can only be obtained on the corresponding fixed output voltage converters, which also require higher minimum input voltage.

The trim pin allows the user to adjust the output voltage set point with an external resistor or voltage. To increase the output voltage, a resistor should be connected between the TRIM pin and the GND pin. The output voltage can be adjusted down by changing the value of the external resistor using the equation below:

$$R_{trim} = \left(\frac{10.5}{\Delta} - 1 \right) (k\Omega)$$

Where $\Delta = V_o - V_{onom}$

For variable output models, $V_{onom} = 0.7525$.

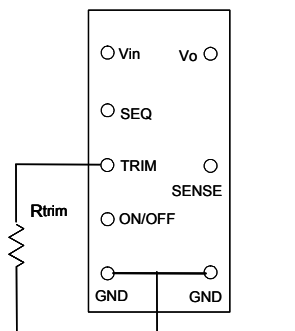

Fig. 15 Circuit to Trim Output Voltage

The circuit configuration for trim operation is shown in Fig. 15. Because NAT1 converters use GND as the reference for control, Rtrim should be placed as close to GND pin as possible, and the trace connecting GND pin and Rtrim should not carry significant current, to reduce the effect of voltage drop on the GND trace/plain on the output voltage accuracy.

When remote sense and trim functions are used simultaneously, please do not allow the output voltage at the converter output terminals to be outside the operating range.

Input Under-Voltage Lockout

This feature prevents the converter from turning on until the input voltage reaches 8.3V. However, for converters with output voltage higher than 5.5V, the input under-voltage lockout setpoint is higher and please contact NetPower for further assistance.

Output Over-Current Protection

As a standard feature, the converter turns off when the load current exceeds the current limit. If the over-current or short circuit condition persist, the converter will operate in a hiccup mode (repeatedly trying to restart) until the over-current condition is cleared.

Thermal Shutdown

As a standard feature, the converter will shut down if an over-temperature condition is detected. The converter has a temperature sensor located within the converter's circuit board, which detects the thermal condition of key components of the converter.

The thermal shutdown circuit is designed to turn the converter off when the temperature at the sensor reaches 120°C. The converter will resume operation after the converter cools down.

Output Over-Voltage Protection

As an optional feature, if the voltage across the output pins exceeds the output voltage protection threshold as shown in the Specifications Table, the converter will clamp the output voltage to protect the converter and the load. The converter automatically resumes normal operation after the over voltage condition is removed.

The typical over-voltage protection setpoint is 125% of the nominal output for fixed output models, and 6.25V for adjustable output model.

Voltage Tracking/Sequencing

An optional voltage tracking/sequencing feature is available with these converters. This feature is compatible with the "Voltage Sequencing" feature



(DOSA) or the "Voltage Tracking" feature (POLA) seen in industry standards. If this feature is not used, the corresponding SEQ pin should be left open, or tied to a voltage higher than the output voltage but less than 15V.

This feature basically forces the output of the converter to follow the voltage at the SEQ pin until it reaches the setpoint during startup, or is completely shutdown during turnoff. The converter's output voltage is controlled to be the same magnitude as the voltage on the SEQ pin, on a 1:1 basis. When using this function, one should pay careful attention to the following aspects:

- 1). This feature is intended mainly for startup and shutdown sequencing control. In normal operation, the voltage at SEQ pin should be maintained higher than the required output voltage, or the SEQ pin is left unconnected;
- 2). The input voltage should be valid for this feature to work. During startup, it is recommended to have a delay of at least 10 ms between the establishment of a valid input voltage, and the application of a voltage at the SEQ pin;
- 3). The ON/OFF pin should be in "Enabled" state when this function is effective.
- 4). The converter's pre-bias startup is affected by this function. The converter will still be able to start under a pre-bias condition, but the output voltage waveform will have a glitch during startup.

Frequency Synchronization

When multiple converters are used in a system, it is desirable to have all converters running at the same switching frequency to avoid the so-called "beat frequency" phenomenon, and reduce the system noise. The switching frequency of this series of POL converters can be synchronized to an outside clock with a frequency at least 10-20 kHz higher than the maximum free-running switching frequency of the converter. For example, for converters with a nominal switching frequency of 300 kHz, the minimum frequency of the synchronous clock should be at least 340 kHz. With the use of synch clock, the under-voltage lock-out (UVLO) point of the converter becomes higher. The Higher the synch frequency is, the higher UVLO becomes. Please contact NetPower if the UVLO point is to remain unchanged with a given synch frequency. The following table shows a relationship between synch frequency and UVLO on a 300 kHz converter:

Synch Freq. (kHz)	340	380	420	460	500	540	580	620	660	700
UVLO (V)	9.5	10	11	11.4	12.1	12.7	14	14	14.8	15.5

The key parameters of the clock signal are: pulse width at least 50nS, logic HIGH level in 2 - 5V, logic LOW level less than 0.8V, and being able to source and sink at least 10 uA current. The clock signal should be connected to the optional PIN B (SEQ pin), which is also used for the optional voltage sequencing (tracking) pin. Therefore, the voltage tracking function and the frequency synchronization function can not be selected at the same time. This pin can be left open or shorted to GND if the synch function is not used.

The effective edge of the synchronization pulse is the falling edge of the clock signal. Through properly phase-shift of the clock signals, multiple converters can work in an interleaved manner, reducing the strength of the switching noise.

Design Considerations

Input Source Impedance and Filtering

The stability of the NAT1 converters, as with any DC/DC converter, may be compromised if the source impedance is too high or too inductive. It's desirable to keep the input source AC impedance as low as possible. To reduce switching frequency ripple current getting into the input circuit (especially the ground/return conductor), it is desirable to place some low ESR capacitors at the input. Due to the existence of some inductance (such as the trace inductance, connector inductance, etc) in the input circuit, possible oscillation may occur at the input of the converter. Because the relatively high input current of low input voltage power system, it may not be practical or economical to have separate damping or soft start circuit in front of POL converters. We recommend to use a combination of ceramic capacitors and Tantalum/Polymer capacitors at the input, so the relatively higher ESR of Tantalum/Polymer capacitors can help damp the possible oscillation between the ceramic capacitors and the inductance.

Similarly, although the converter is designed to be stable without external capacitor at the output, some low ESR capacitors at the output may be desirable to further reduce the output voltage ripple or improve

the transient response. Again, a combination of ceramic capacitors and Tantalum/Polymer capacitors usually can achieve good results.

Safety Considerations

To meet safety requirements of the system, the converter shall be used in accordance with the requirements of end-use equipment safety standards. If a fuse is to be used at the input, it's recommended to use a fast blow fuse with adequate current rating.

The converter's output meets SELV requirements if all of its input meet SELV requirements.

Thermal Considerations

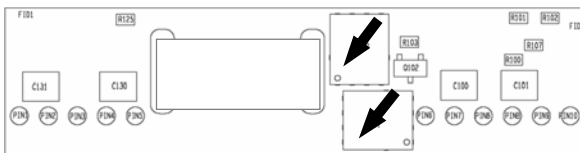

Figure 16. Temperature Monitoring Locations

The NAT1 converters can operate in various thermal environments. Due to the high efficiency and optimal heat distribution, these converters exhibit excellent thermal performance. Proper cooling in the end system can be verified by monitoring the temperature of the key components. Figure 16 shows recommended temperature monitoring points. The temperature at these locations should not exceed 120°C continuously.

The maximum allowable output power of any power converter is usually determined by the electrical design and the maximum operating temperature of its components. The NAT1 converters have been tested comprehensively under various conditions to generate the derating curves with consideration for long term reliability.

Thermal derating curves are highly influenced by derating guide, the test conditions and test setup, such as test temperatures, the interface method between the converter and the test fixture board,

spacing and construction (especially copper weight, holes and openings) of the fixture board and the spacing board, temperature measurement method, and the ambient temperature measurement point. The thermal derating curves in this datasheet are obtained by thermal tests in a windtunnel at 25°C, 55°C, 70°C, and 85°C. The converter's power pins are soldered to a 2-layer test fixture board through 18 AWG wires. The space between the test board and a PWB spacing board is 1". Usually, the end system board has more layer count, and has better thermal conduction than our test fixture board. For thermal considerations specific to your application environment, please contact NetPower's technical support team for assistance.

Heat Transfer without a Baseplate or Heatsink

Convection heat transfer is the primary cooling means for converters without a baseplate. Therefore, airflow speed is important for any intended operating environment. Increasing the airflow over the converter enhances the heat transfer via convection.

Figures 12 (a) through (f) show the current derating curves under nominal input voltage for a few output voltages. To maintain long-term reliability, the module should be operated within these curves in steady state. Note: the natural convection condition can be measured from 0.05 - 0.15 m/s (10 - 30 LFM).

Heat Transfer with a Baseplate or Heatsink

The NAT1 converter can use a baseplate to further enhance their thermal performance. A baseplate works as a heat spreader, and thus can improve the heat transfer between the converter and its ambient.

An additional heatsink or cold-plate can be attached to the baseplate with external mechanical attachment. The heatsink/cold plate further improves the thermal performance of the converter.



NAT Converter Part Numbering System:

NAT	1	000	N	20	R	1	6	
Series Name:	Nominal Input Voltage:	Nominal Output Voltage:	Enabling Logic:	Rated Output Current:	Pin Length:	Electrical Option 1:	Mechanical Options	
							Lead-free, ROHS Compliant	Leaded (ROHS-5 Compliant)
NAT	1: 8.5 – 18V	000 = adj	P: Positive N: Negative	20 = 20A	R: 0.2"	0: None 1: output tracking 2: output OVP 3: tracking and OVP 4: Frequency Synch 5: OVP and Synch	5: None 6: Baseplate	0: None 1: Baseplate

*: fixed output models are available as semi-custom products

The above example denotes a 20A output converter in Pb-free (RoHS compliant) with negative enabling logic, and voltage tracking options.



Mechanical Information

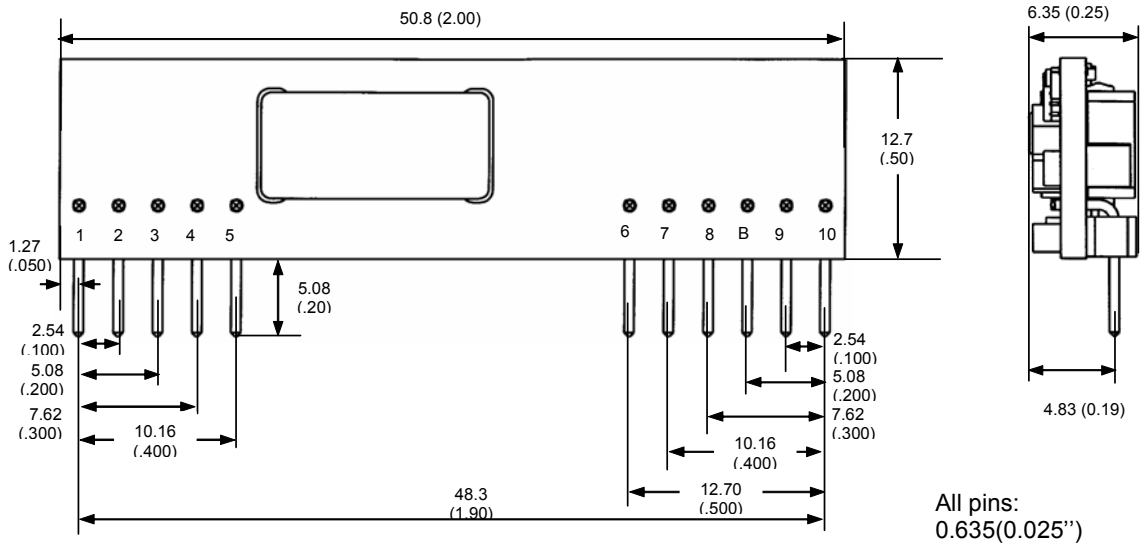

Pin#	1	2	3	4	5	6	7	8	B	9	10
Function	Vo	Vo	Sense	Vo	GND	GND	Vin	Vin	SEQ	Trim	ON/OFF

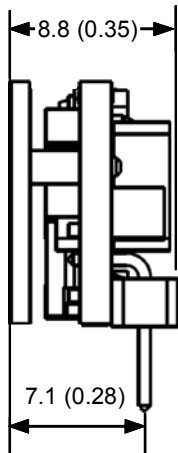

Side View with Baseplate

Notes

- 1) All dimensions in mm (inch) (1 inch = 25.4mm). Tolerances:
.x (.xx): ± 0.5 (0.020")
.xxx: ± 0.25 (0.010")
- 2) All pins are 0.635mm (0.025") square.
- 3) A converter's thickness is increased to 0.35" with a baseplate option.
- 3) All pins are coated with 90%/10% solder finish, or Matte Tin, or Gold.
- 4) Weight: 7 g open frame converter
- 5) Workmanship: Meet or exceeds IPC-A-610 Class II
- 6) Baseplate flatness tolerance is 0.10mm (0.004") TIR for surface.

For more information, please contact:

NetPower Technologies, Inc.
Toll Free: 866-NETPOWER (866-638-7693)
Local Phone: 972-560-0500
Fax: 972-560-0210
E-mail: sales@netpowercorp.com
www.netpowercorp.com
1680 Prospect Drive #200, Richardson, TX 75081

Warranty

NetPower offers a two (2) year limited warranty. Complete warranty information is listed on our web site or is available upon request. Information furnished by NetPower is believed to be accurate and reliable. However, no responsibility is assumed by NetPower for its use, nor for any infringements of patents or other rights of third parties which may result from its use. No license is granted by implication or otherwise under any patent or patent rights of NetPower.