

NAS3XXX SMT Non-Isolated Point-of-Load Converters

18V – 36V input, 5V-15.5V 9A/60W output



RoHS Compliant Parts Available

Features

- High efficiency, 94% (24Vin, 12Vout@5A)
- Excellent thermal performance
- High output current/Power: 9A/60W
- High input-voltage range: 18 - 36V
- Wide output-voltage range: 5V to 15.5V
- Monotonic start-up into pre-biased load
- Output trim, Remote sense
- Remote enable control
- Small footprint: 1.3''x0.53''x0.25''
- All components meet UL 94V0

Applications

- Intermediate bus architecture
- Industrial, telecom, and networking equipment
- Electronic data processing, servers
- Distributed power architectures

Options

- Baseplate
- Negative/Positive enable logic
- Output over-voltage protection
- Output voltage tracking/Sequence

This *NAS* non-isolated point-of-load (POL) dc-dc converter delivers up to 9A current or 60W power in an industry standard SMT package with high efficiency and unparalleled thermal performance. The high input voltage allows it to be used in applications where traditionally isolated converter has to be used, achieving significant cost, space, and performance advantages. The output voltage of this converter can be programmed in the range of 5V – 15.5V. The wide input/output voltage ranges, high power density, and user-friendly features are ideal for today's industrial, telecom, datacom, wireless networks, computing, and automotive applications.

This *NAS* converter provides competitive cost, high performance, high reliability and quality, and flexibility of use in a wide range of applications. The open frame design with integrated magnetics has a low profile (0.25''), achieving industry-leading power density and enhanced airflow for nearby components. As a benefit of the high efficiency and resulting superior thermal performance, these converters can provide high output currents in challenging environments with simple thermal management. This converter provides input under-voltage lockout, remote sense, wide output voltage trim, overload and short circuit protection and over-temperature shutdown as standard features. NetPower also offers several optional features to allow system designers the freedom required to optimize the system performance. The optional output over-voltage protection provides increased protection and system reliability in practical applications. The optional output voltage sequence/tracking feature allows the output voltage to track an external signal during startup and shutdown in systems with sensitive powering timing requirements. To further improve thermal performance, and provide flexibility to be used in conduction-cooled systems, the baseplate option provides necessary thermal management enhancement for the challenging environment common in many of today's electronic systems.

† UL is a registered trademark of Underwriters Laboratory Inc.

Absolute Maximum Ratings

Excessive stresses over these absolute maximum ratings can cause permanent damage to the converter. Also, exposure to absolute maximum ratings for extended periods of time can adversely affect the reliability of the converter. Operation should be limited to the conditions outlined under the Electrical Specification Section.

Parameter	Symbol	Min	Max	Unit
Input Voltage (continuous)	V_i	-0.5	38.5	Vdc
Operating Ambient Temperature (See Thermal Consideration section)	T_o	-40	85*	°C
Storage Temperature	T_{stg}	-55	125	°C

* For operation above 85°C ambient temperature, please consult NetPower for derating guidance.

Electrical Specifications

These specifications are valid over the converter's full range of input voltage, resistive load, and temperature unless noted otherwise.

Input Specifications

Parameter	Symbol	Min	Typ	Max	Unit
Input Voltage	V_i	18	24	36	Vdc
Input Current	$I_{i,max}$	-	-	4	A
Quiescent Input Current ($V_{in} = 24$, $V_o = 3.3V$)	$I_{i,Qsnt}$	-	50	70	mA
Standby Input Current	$I_{i,standby}$	-	2	-	mA
Inrush Transient	I^2t	-	-	0.5	A ² s
Input Reflected-ripple Current, Peak-to-peak (5 Hz to 20 MHz, 1 μ H source impedance)	-	-	20	-	mA _{p-p}
Input Ripple Rejection (120 Hz)	-	-	30	-	dB
Input Turn-on Voltage Threshold	-	-	17	-	V

Output Specifications

Parameter	Symbol	Min	Typ	Max	Unit
Output Voltage Set Point Tolerance ($V_i = 12$ V; $I_o = I_{o,max}$; $T_a = 25^\circ$ C)	-	-2.0	-	2.0	%
Output Voltage Set Point Tolerance (over all conditions)	-	-2.5	-	3.50	%
Output Regulator:					
Line Regulation ($V_i = 9V$ to $36V$, $I_o = 1/2$ of load)	-	-	0.2	-	% V_o
Load Regulation ($I_o = I_{o,min}$ to $I_{o,max}$, $V_i = 24V$)	-	-	0.3	-	% V_o
Temperature ($T_a = -40^\circ$ C to 85° C)	-	-	0.2	-	% V_o
Output Ripple and Noise Voltage (5 Hz to 20 MHz bandwidth, $V_{in} = 24V$)	Peak-to-peak -	-	2	-	% V_o
	RMS	-	-	1	% V_o
External Load Capacitance	-	-	-	2,000	μ F
Output Current	I_o	0	-	9	A
Output Power	P_o	0	-	60	W
Output Current-limit Trip Point	$I_{o,cli}$	-	170	-	% $I_{o,max}$
Output Short-circuit Current, hiccup mode	-	-	2	-	A
Switching frequency	-	405	450	495	kHz
Output Over Voltage trip point (optional, hiccup mode)	-	115	125	135	% V_o
Voltage Tracking/Sequencing Slew Rate – Power UP	-	-	-	2	V/ms
Voltage Tracking/Sequencing Slew Rate – Power down	-	-	-	1	V/ms

Output Specifications (continued)

Parameter	Symbol	Min	Typ	Max	Unit
Efficiency ($V_i = 24V$; $T_A = 25^\circ C$)	$V_o = 5V, I_o = 9A$		88		%
	$V_o = 12V, I_o = 5A$		94		%
Dynamic Response ($V_i = 24V$; $T_a = 25^\circ C$; Load transient $0.1A/\mu s$) Load step from 75% to 100% of full load: Peak deviation Settling time (to 10% band of V_o deviation)					mV μs
Load step from 100% to 75% of full load: Peak deviation Settling time (to 10% band of V_o deviation)					mV μs

General Specifications

Parameter	Symbol	Min	Typ	Max	Unit
Remote Enable					
Negative Logic:					
Logic Low – Module On	-	-	-	-	-
Logic High – Module Off					
Positive Logic:					
Logic High – Module On	-	-	-	-	-
Logic Low – Module Off					
Logic Low:					
$I_{ON/OFF} = 1.0mA$	$V_{ON/OFF}$	0	-	1.2	V
$V_{ON/OFF} = 0.0V$	$I_{ON/OFF}$	-	-	1.0	mA
Logic High:					
$I_{ON/OFF} = 0.0\mu A$	$V_{ON/OFF}$	-	-	15	V
Leakage Current	$I_{ON/OFF}$	-	-	50	μA
		-			
Over-temperature Protection	T_o	-	120	-	$^\circ C$
Turn-on Time ($I_o =$ full load, V_o within 1% of setpoint)	-	-	6	-	ms
Calculated MTBF (Bellcore TR-332, $40^\circ C$, full load)			>5		10^6 -hour

Characteristic Curves

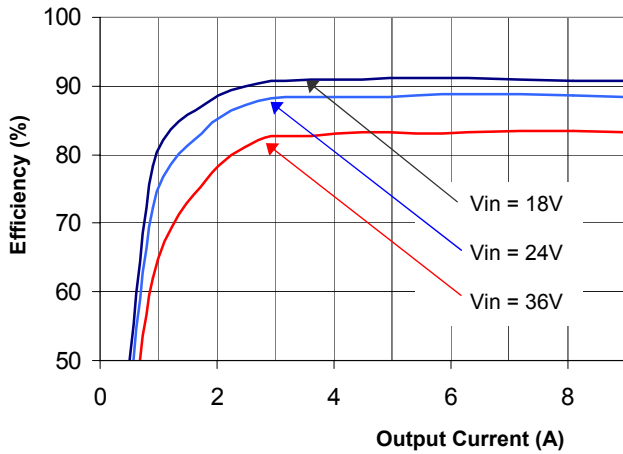

Figure 1(g). Efficiency vs. Load Current (25°C, 5V output)

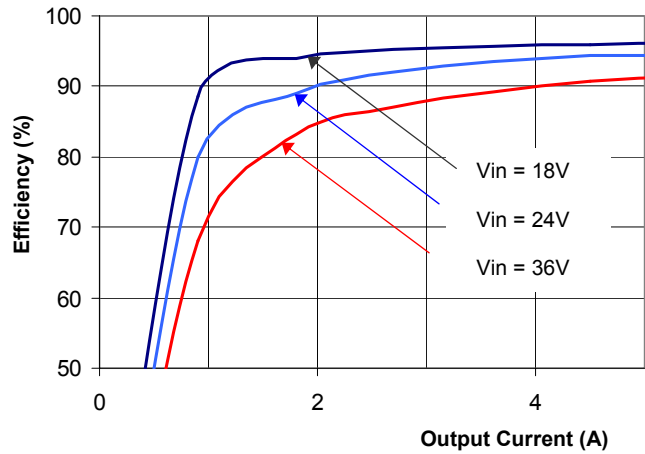

Figure 1(h). Efficiency vs. Load Current (25°C, 12V output)

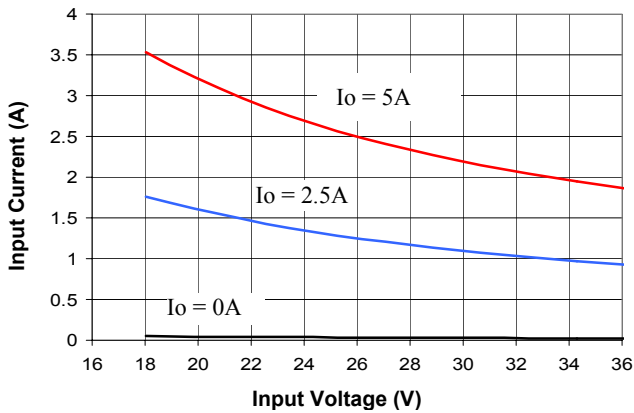

Figure 2. Input Characteristic (12V output)

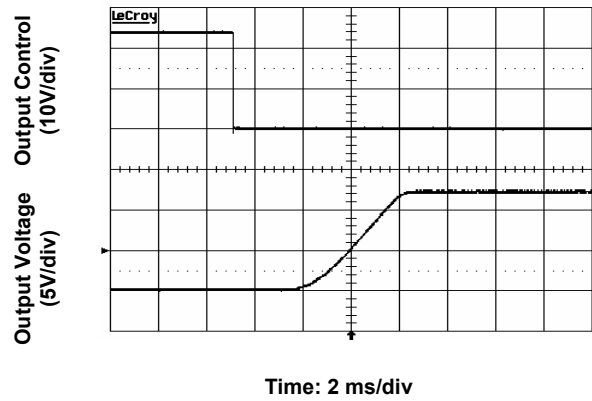

Figure 3. Start-Up from Enable Control Input voltage 24V, Output current 5A, output voltage 12V.

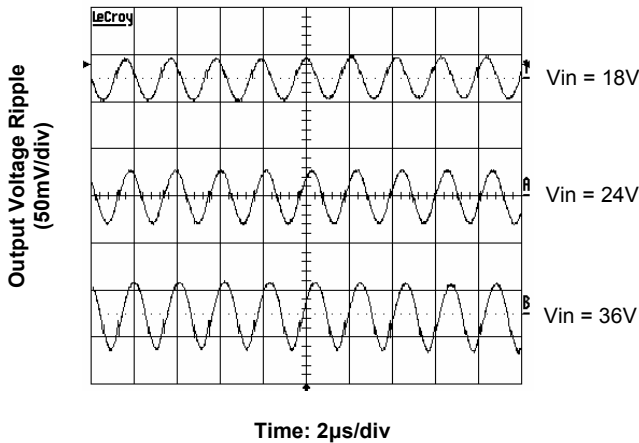

Figure 4. Output Ripple Voltage at 5V, 9A Output

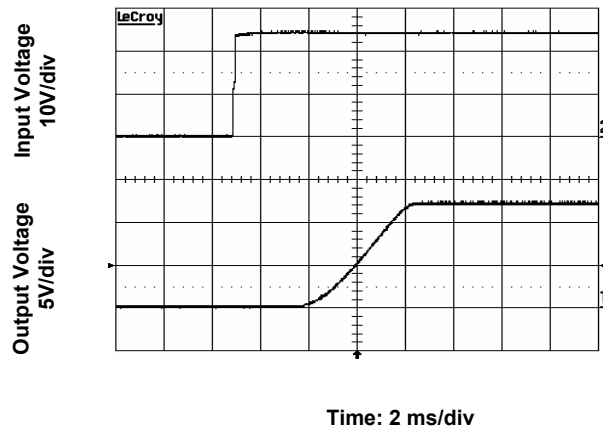

Figure 5. Start-Up from Application of Input Voltage Input voltage 24V, output current 5A, output voltage 12V.

Characteristic Curves

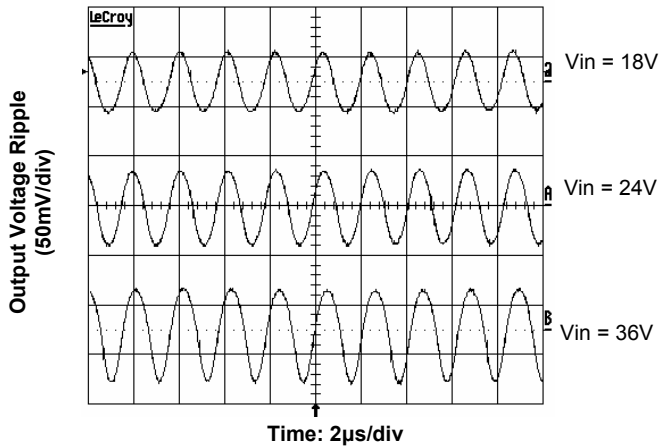

Figure 6. Output Ripple Voltage at 12V, 5A Output

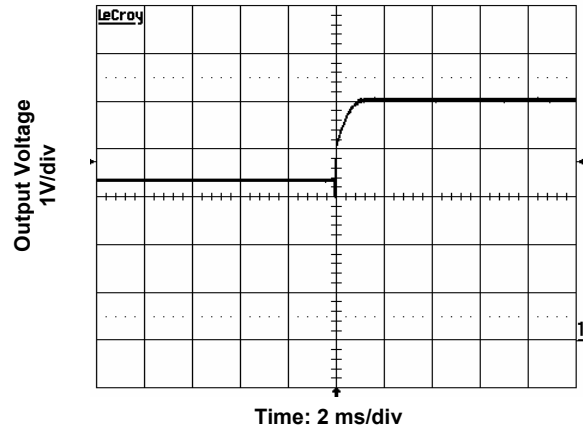

Figure 7. Start-Up with Prebias Input voltage 24V, Output current 0A, Output voltage 5V, Prebias 3.3V

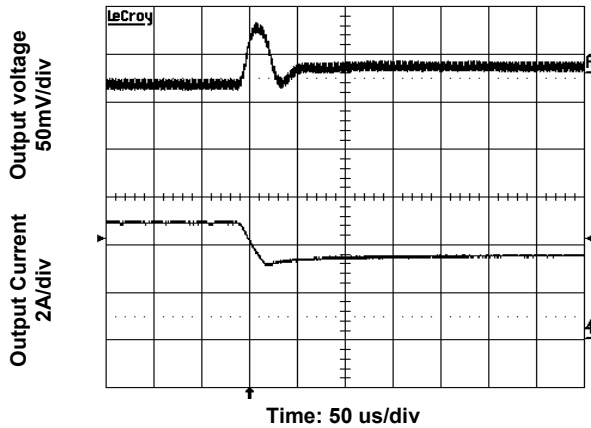

Figure 8. Transient Load Response Input/output voltage 24/12V, Output current 5A->3.75A, Slew rate 0.1A/µs.

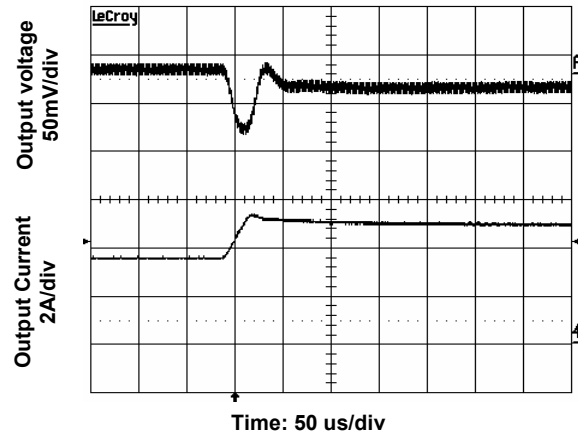

Figure 9. Transient Load Response Input/output voltage 24/12V, Output current 3.75A->5A, Slew rate 0.1A/µs .

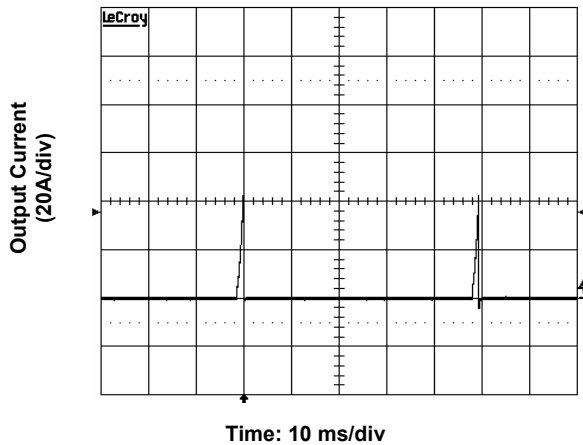

Figure 10. Short Circuit Current. $V_{in} = 24V$

Figure 11. TBD

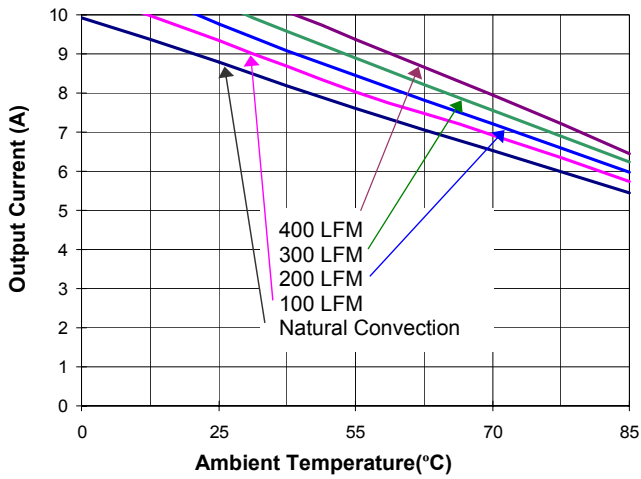

Figure 12(a). Current Derating Curve for 5V Output ($V_{in} = 24V$ open frame)

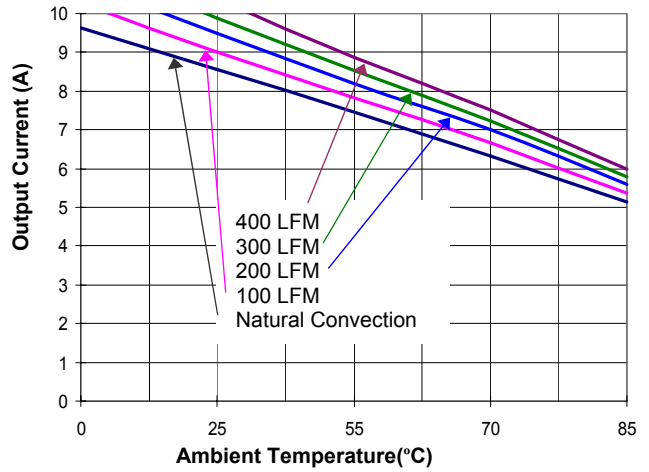

Figure 12(b). Current Derating Curve for 12V Output ($V_{in} = 24V$ open frame)

Feature Descriptions

Remote ON/OFF

The converter can be turned on and off by changing the voltage or resistance between the ON/OFF pin and GND. The NAS converters can be ordered with factory selectable positive logic or negative enabling logic.

For the negative control logic, the converter is ON when the ON/OFF pin is at a logic low level, and OFF when the ON/OFF pin is at a logic high level. With positive control logic, the converter is ON when the ON/OFF pin is at a logic high level and OFF when the ON/OFF pin is at a logic low level.

With the internal pull-up circuitry, a simple external switch between the ON/OFF pin and GND can control the converter. A few example circuits for controlling the ON/OFF pin are shown in Figs. 13, 14 and 15.

The logic-low level is from 0V to 1.2V, and the maximum switch current during logic low is 1mA. The external switch must be capable of maintaining a logic-low level while sinking this current. The maximum ON/OFF pin voltage, generated by the converter internal circuitry for logic-high level, is less than 10V. The maximum allowable leakage current from this pin at logic-high level is 50 μ A.

When the ON/OFF pin is left unconnected (floating), the converter is enabled.

Remote SENSE

The remote SENSE pin is used to sense voltage at the load point to accurately regulate the load voltage and eliminate the impact of the voltage drop in the power distribution path.

The SENSE pin should be connected to the point where regulation is desired. The voltage difference between the output pins must not exceed the operating range of this converter shown in the specification table.

When remote sense is not used, the SENSE pin can be connected to the positive output terminals. If the SENSE pins are left floating, the converter will deliver an output voltage slightly higher than its specified typical output voltage. The OVP (output over-voltage protection) circuit senses the voltage across the

output pins, so the total voltage rise should not exceed the minimum OVP setpoint given in the Specifications Table in operation.

Because the converter does not have remote sense connection for GND, it is important to make sure that the connection resistance and voltage drop between GND pin and the load is small.

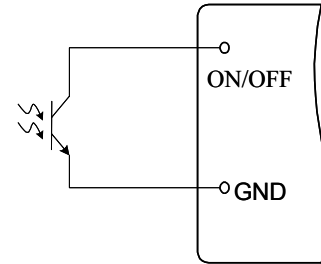

Figure 13. Opto Coupler Enable Circuit

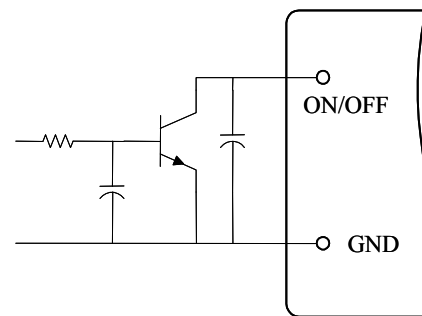

Figure 14. Open Collector Enable Circuit

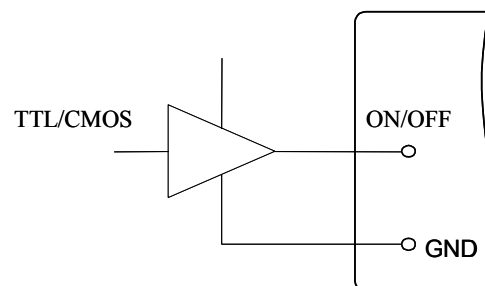

Figure 15. Direct Logic Drive

Output Voltage Programming and Adjustment

The output voltage of this converter is preset to 5.021V as a default. Customers can also order 12V or 15V as the preset voltage by indicating the desired voltage in the part number. The output voltage be trimmed up to 15.5V using an external trim resistor. To trim the voltage lower than the preset voltage, an external voltage higher than the nominal voltage has to be applied to the Trim pin.

The trim pin allows the user to adjust the output voltage set point with an external resistor or voltage. If the trim pin is open, the converter outputs preset voltage. If the trim pin is shorted to GND, the converter outputs 15.521V. To program the output voltage, a resistor should be connected between the Trim pin and the GND pin. The output voltage can be adjusted down by changing the value of the external resistor using the equation below:

$$R_{trim} = \left(\frac{10.5}{\Delta} - 1 \right) (k\Omega)$$

Where $\Delta = V_o - V_{onom}$

$V_{onom} = 5.021$ as a default, or is the preset voltage ordered.

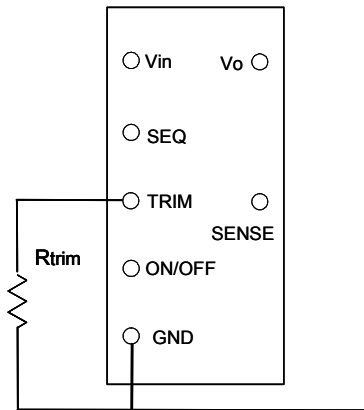

Fig. 16 Circuit to Trim Output Voltage

The circuit configuration for trim operation is shown in Fig. 16. Because NAS converters use GND as the reference for control, Rtrim should be placed as close to GND pin as possible, and the trace connecting GND pin and Rtrim should not carry significant current, to reduce the effect of voltage drop on the GND trace/plain on the output voltage accuracy.

When use remote sense and trim functions

simultaneously, do not allow the output voltage at the converter output terminals to be outside the operating range.

Input Under-Voltage Lockout

This feature prevents the converter from turning on until the input voltage reaches about 17V.

Output Over-Current/Short-Circuit Protection

This converter is designed to operate within 9A of output current and 60W of output current if the output voltage is higher than 7V. The converter turns off when the load current exceeds the current limit. If the over-current or short circuit condition persist, the converter will operate in a hiccup mode (repeatedly trying to restart) until the over-current condition is cleared.

Thermal Shutdown

As a standard feature, the converter will shut down if an over-temperature condition is detected. The converter has a temperature sensor located within the converter's circuit board, which detects the thermal condition of key components of the converter.

The thermal shutdown circuit is designed to turn the converter off when the temperature at the sensor reaches 120°C. The converter will resume operation after the converter cools down.

Output Over-Voltage Protection

As an optional feature, if the voltage across the output pins exceeds the output voltage protection threshold as shown in the Specifications Table, the converter will clamp the output voltage to protect the converter and the load. The converter automatically resumes normal operation after the over voltage condition is removed.

The typical over-voltage protection setpoint for this converter is 25% higher than nominal output, or 18.75V for adjustable output models.

Voltage Tracking/Sequencing

An optional voltage tracking/sequencing feature is

available with this converter for output voltage up to 8V. This feature is compatible with the “Voltage Sequencing” feature (DOSA) or the “Voltage Tracking” feature (POLA) seen in industry standards. If this feature is not used, the corresponding SEQ pin should be left open, or tied to a voltage higher than the output voltage but less than 10V.

The tracking feature is not available when output voltage is higher than 8V.

This feature basically forces the output of the converter to follow the voltage at the SEQ pin until it reaches the setpoint during startup, or is completely shutdown during turnoff. The converter’s output voltage is controlled to be the same magnitude as the voltage on the SEQ pin, on a 1:1 basis. When using this function, one should pay careful attention to the following aspects:

- 1). This feature is intended mainly for startup and shutdown sequencing control. In normal operation, the voltage at SEQ pin should be maintained higher than the required output voltage, or the SEQ pin is left unconnected;
- 2). The input voltage should be valid for this feature to work. During startup, it is recommended to have a delay of at least 10 ms between the establishment of a valid input voltage, and the application of a voltage at the SEQ pin;
- 3). The ON/OFF pin should be in “Enabled” state when this function is effective.
- 4). The converter’s pre-bias startup is affected by this function. The converter will still be able to start under a pre-bias condition, but the output voltage waveform will have a glitch during startup.

Design Considerations

Input Source Impedance and Filtering

The stability of the NAS converters, as with any DC/DC converter, may be compromised if the source impedance is too high or too inductive. It’s desirable to keep the input source AC impedance as low as possible. To reduce switching frequency ripple current getting into the input circuit (especially the ground/return conductor), it is desirable to place some low ESR capacitors at the input. Ceramic capacitors of at least 10uF total capacitance are recommended. Due to the existence of inductance (such as the trace inductance, connector inductance, etc) in the input circuit, possible oscillation may occur

at the input of the converter. Because the relatively high input current of low input voltage power system, it may not be practical or economical to have separate damping or soft start circuit in front of POL converters. We recommend to use a combination of ceramic capacitors and Tantalum/Polymer/Aluminum capacitors at the input, so the relatively higher ERS of Tantalum/Polymer capacitors can help damp the possible oscillation between the ceramic capacitors and the inductance.

Similarly, although the converter is designed to be stable without external capacitor at the output, some low ESR capacitors at the output may be desirable to further reduce the output voltage ripple or improve the transient response. Again, a combination of ceramic capacitors and Tantalum/Polymer/Aluminum capacitors usually can achieve good results.

Safety Considerations

To meet safety requirements of the system, the converter shall be used in accordance with the requirements of end-use equipment safety standards. If a fuse is to be used at the input, it’s recommended to use a fast blow fuse with adequate current rating.

The converter’s output meets SELV requirements if its input meets SELV requirements.

Thermal Considerations

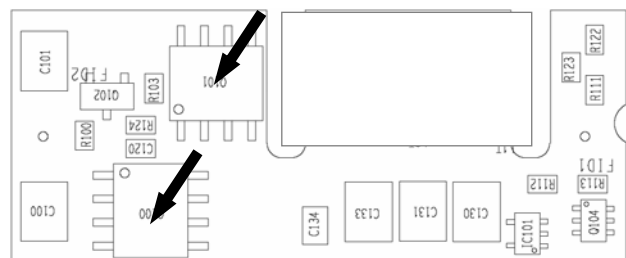

Figure 17. Temperature Monitoring Locations

The NAS converters can operate in various thermal environments. Due to the high efficiency and optimal heat distribution, these converters exhibit excellent thermal performance. Proper cooling in the end system can be verified by monitoring the temperature of the key components. Figure 17 shows recommended temperature monitoring points. The

temperature at these locations should not exceed 120 °C continuously.

The maximum allowable output power of any power converter is usually determined by the electrical design and the maximum operating temperature of its components. The NAS converters have been tested comprehensively under various conditions to generate the derating curves with consideration for long term reliability.

Thermal derating curves are highly influenced by derating guide, the test conditions and test setup, such as test temperatures, the interface method between the converter and the test fixture board, spacing and construction (especially copper weight, holes and openings) of the fixture board and the spacing board, temperature measurement method, and the ambient temperature measurement point. The thermal derating curves in this datasheet are obtained by thermal tests in a wind-tunnel at 25°C, 55°C, 70°C, and 85°C. The converter's power pins are soldered to a 2-layer test fixture board through 18 AWG wires. The space between the test board and a PWB spacing board is 1". Usually, the end system board has more layer count, and has better thermal conduction than our test fixture board. For thermal considerations specific to your application environment, please contact NetPower's technical support team for assistance.

Heat Transfer without a Baseplate or Heatsink

POL Converter Part Numbering System:

NAS	3	120	N	05	S	1	5	
Series Name:	Nominal Input Voltage:	Nominal Output Voltage:	Enabling Logic:	Rated Output Current:	Pin Length:	Electrical Option 1:	Mechanical Options	
							Lead-free, ROHS Compliant	Leaded (ROHS-5 Compliant)
NAS	0: 2.5-5.5V 1: 8.5 – 18V 2: 9 – 36V 3: 18 – 36V	Unit: 0.1V 050 = 5V 000 = adj	P: Positive N: Negative	Unit: A 009 = 9A	S: SMT	0: None 1: output tracking 2: output OVP 3: tracking and OVP	5: None 6: Baseplate	0: None 1: Baseplate

Standard fixed output voltages include: 5V, 8V, 12V, and 15V.

The tracking feature is not available when output voltage is higher than 8V.

The above example denotes a 12V, 5A output converter in Pb-free (RoHS compliant) with negative enabling logic, and voltage tracking options.

Convection heat transfer is the primary cooling means for converters without a baseplate. Therefore, airflow speed is important for any intended operating environment. Increasing the airflow over the converter enhances the heat transfer via convection.

Figures 12 (a) through (f) show the current derating curves under nominal input voltage for a few output voltages. To maintain long-term reliability, the module should be operated within these curves in steady state. Note: the natural convection condition can be measured from 0.05 - 0.15 m/s (10-30 LFM).

Heat Transfer with a Baseplate or Heatsink

The NAS converter can use a baseplate to further enhance their thermal performance. A baseplate works as a heat spreader, and thus can improve the heat transfer between the converter and its ambient.

An additional heatsink or cold-plate can be attached to the baseplate with external mechanical attachment. The heatsink/cold plate further improves the thermal performance of the converter.

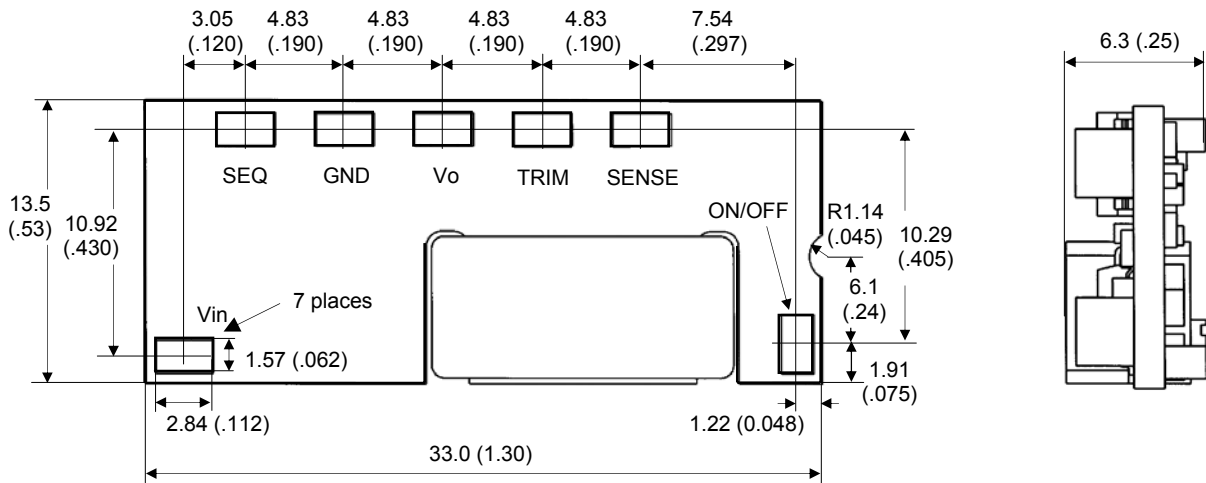
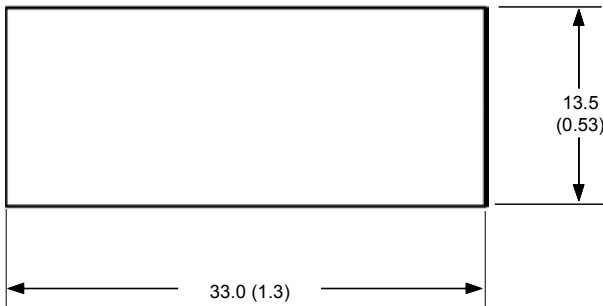
Mechanical Drawing dimensions in mm(inch)

Bottom View
Side View

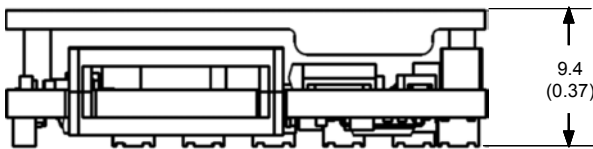
Notes

- 1) All dimensions in mm (inches). Tolerances:
 $x \pm .5$ ($.xx \pm 0.02$)
 $.xx \pm .25$ ($.xxx \pm 0.010$)
- 2) All pins are coated with gold or Matte Tin finish
- 3) Weight: 0.25oz(7g) open frame converter
- 4) Workmanship: Meet or exceed IPC-A-610 Class II
- 5) Baseplate flatness tolerance is 0.10mm (0.004") TIR for surface.

Converter with Baseplate
For more information, please contact:

NetPower Technologies, Inc.
 Toll Free: 866-NETPOWER (866-638-7693)
 Local Phone: 972-560-0500
 Fax: 972-560-0210
 E-mail: sales@netpowercorp.com
www.netpowercorp.com
 1680 Prospect Drive #200, Richardson, TX 75081

Warranty

NetPower offers a two (2) year limited warranty. Complete warranty information is listed on our web site or is available upon request. Information furnished by NetPower is believed to be accurate and reliable. However, no responsibility is assumed by NetPower for its use, nor for any infringements of patents or other rights of third parties which may result from its use. No license is granted by implication or otherwise under any patent or patent rights of NetPower.