

**1/8-Brick**



## Features

- High efficiency, 84.5% (1.0V/30A)
- 40% smaller footprint than quarter-brick
- Industry standard quarter-brick pinout
- Optimal thermal performance
- Low profile, 0.37" (9.4mm)
- Monotonic start-up into pre-biased load
- No minimum load required
- Optional baseplate available
- High reliability (>3.2 10<sup>6</sup> -hour)
- Fixed frequency operation
- Basic insulation, 1500V
- UL<sup>†</sup>60950 recognized
- ROHS Compliant

## Applications

- Wireless Networks
- Telecom / Datacom
- Electronic Data Processing / Servers
- Distributed Power Architectures

## Options

- Through-hole / surface mount package
- Baseplate
- Auto-restart after fault shutdown
- Negative / Positive enable logic
- Various standard lead lengths

NetPower Technologies ERS Series of 1/8-Brick DC/DC Converters utilize proprietary technologies to achieve market leading efficiencies and thermal performance in the latest industry standard package. The new 1/8-brick package makes use of the standard quarter-brick pinout while reducing the overall package size by 40%, thus saving valuable customer real estate. The ERS Series incorporates automated assembly techniques on a single board, planar magnetic, patented design which provides extreme high reliability. NetPower offers both a through-hole and surface mount package version of this product to provide customers more freedom in their manufacturing processes (and reduced costs). The low profile, open frame design provides industry leading thermal performance and does not require a baseplate making the ERS Series an excellent choice for today's densely packed systems.

NetPower's 1/8-brick provides a monotonic start-up from both the input voltage and the ON/OFF control under all load conditions (including pre-biased output). These converters have a fast dynamic response and are stable over the full range of input voltage, load current, load capacitance, capacitor ESR, and temperature. The critical line and load regulations are tight, and the converters are fully protected from abnormal conditions of input/output voltages, output current and operating temperature. NetPower's converters are an ideal choice for any limited board space, high current and/or low output voltage applications such as telecom, datacom, wireless networks, or servers.

<sup>†</sup> UL is a registered trademark of Underwriters Laboratory Inc.

## Absolute Maximum Ratings

Excessive stresses over these absolute maximum ratings can cause permanent damage to the converter. Also, exposure to absolute maximum ratings for extended periods of time can adversely affect the reliability of the converter. Operation should be limited to the conditions outlined under the Electrical Specification Section.

Parameter	Symbol	Min	Max	Unit
Input Voltage (continuous)	$V_i$	-0.5	80	Vdc
Transient Input Voltage (<100ms continuous operating)	$V_{i,trans}$	-	100	Vdc
I/O Isolation Voltage (for 1 minute)		1500	-	Vdc
Operating Ambient Temperature (See Thermal Consideration section)	$T_o$	-40	85*	°C
Storage Temperature	$T_{stg}$	-55	125	°C

\* For operation above 85°C ambient temperature, please consult NetPower for derating guidance.

## Electrical Specifications

The specifications are valid over all operating conditions including input voltage, resistive load, and temperature except as noted.

### Input Specifications

Parameter	Symbol	Min	Typ	Max	Unit
Input Voltage	$V_i$	36	48	75	Vdc
Input Current	$I_{i,max}$	-	-	1.6	A
Quiescent Input Current ( $V_{in} = 48V$ )	$I_{i,Qsnt}$	-	40	70	mA
Standby Input Current	$I_{i,stdby}$	-	4	6	mA
Inrush Transient	$I^2t$	-	-	1.0	A <sup>2</sup> s
Input Reflected-ripple Current, Peak-to-peak (5 Hz to 20 MHz, 12 $\mu$ H source impedance)	-	-	10	-	mA
Input Ripple Rejection (120 Hz)	-	-	60	-	dB
Input Turn-on Voltage Threshold	-	34	35	36	V
Input Turn-off Voltage Threshold	-	29	32	33	V
Input Voltage ON/OFF Hysteresis	-	1	3	4	V

### Output Specifications

Parameter	Symbol	Min	Typ	Max	Unit
Output Voltage Set Point ( $V_i = 48V$ ; $I_o = I_{o,max}$ ; $T_a = 25^\circ C$ )	-	0.98	1.0	1.02	Vdc
Output Voltage Set Point (over all conditions)	-	0.97	-	1.03	Vdc
Output Regulation:					
Line Regulation ( $V_i = 36V$ to $75V$ , $I_o = 1/2$ of load)	-	-	0.05	0.2	%Vo
Load Regulation ( $I_o = I_{o,min}$ to $I_{o,max}$ , $V_i = 48V$ )	-	-	0.05	0.2	%Vo
Temperature ( $T_a = -40^\circ C$ to $85^\circ C$ )	-	-	15	50	mV
Output Ripple and Noise Voltage RMS	-	-	-	15	mVrms
Peak-to-peak (5 Hz to 20 MHz bandwidth, $V_{in} = 48V$ )	-	-	-	40	mVp-p
External Load Capacitance	-	-	-	10,000	$\mu$ F
Output Current	$I_o$	0	-	30	A
Output Power	$P_o$	0	-	30	W

**Output Specifications (continued)**

Parameter	Symbol	Min	Typ	Max	Unit
Output Current-limit Trip Point ( $V_o = 90\%$ of $V_{o,nom}$ )	$I_{o,cli}$	30.9	37.0	39.0	A
Output Short-circuit Current					A
Efficiency ( $V_i = 48V$ ; $I_o = I_{o,max}$ , $T_A = 25^\circ C$ )	$\eta$	-	84	-	%
Output Over Voltage trip point		1.13	1.25	1.38	V
Switching frequency	-	180	200	220	kHz
Dynamic Response ( $V_i = 48V$ ; $T_A = 25^\circ C$ ; Load transient $0.1A/\mu s$ )					
Load step from 50% to 75% of full load:					
Peak deviation			8		% $V_o$
Settling time (to 10% band of $V_o$ deviation)			200		$\mu s$
Load step from 50% to 25% of full load:					
Peak deviation			8		% $V_o$
Settling time (to 10% band of $V_o$ deviation)			200		$\mu s$

**General Specifications**

Parameter	Symbol	Min	Typ	Max	Unit
Remote Enable					
Negative Logic:					
Logic Low – Module On	-	-	-	-	-
Logic High – Module Off					
Positive Logic:					
Logic High – Module On	-	-	-	-	-
Logic Low – Module Off					
Logic Low:					
$I_{ON/OFF} = 1.0mA$	$V_{ON/OFF}$	0	-	1.2	V
$V_{ON/OFF} = 0.0V$	$I_{ON/OFF}$	-	-	1.0	mA
Logic High:					
$I_{ON/OFF} = 0.0\mu A$	$V_{ON/OFF}$	-	-	15	V
Leakage Current	$I_{ON/OFF}$	-	-	50	$\mu A$
Turn-on Time ( $I_o =$ full load, $V_o$ within 1% of setpoint)		-	4	8	ms
Output Voltage Trim Range	-	80	-	110	% $V_o$
Output Voltage Remote-sense Range	-	-	-	0.5	V
Output Current Sharing Accuracy (at rated load)	-	-	-	10	%
Over-temperature Protection	$T_o$	-	120	-	$^\circ C$
Isolation Capacitance	-	-	1200	-	pF
Isolation Resistance	-	10	-	-	M $\Omega$
Calculated MTBF (Bellcore TR-332)			3.2		$10^6$ -hour

## Characteristic Curves

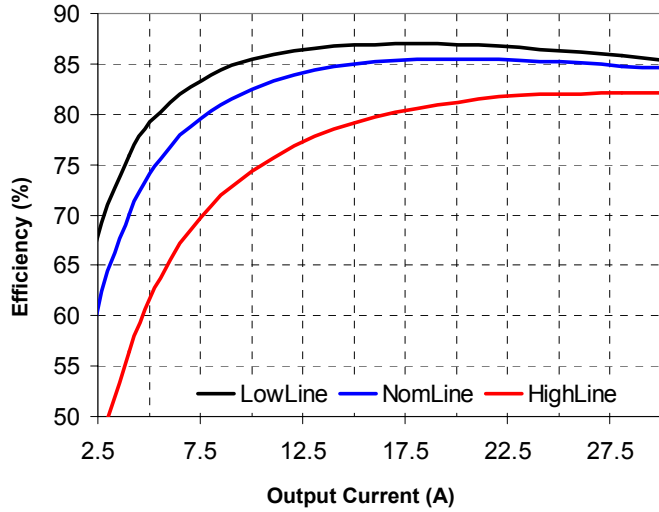

Figure 1. Efficiency vs. Load Current (25°C)

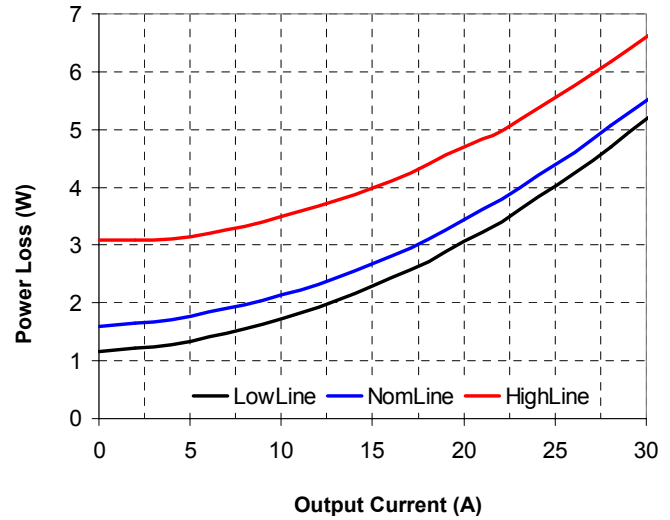

Figure 2. Power Loss vs. Load Current (25°C)

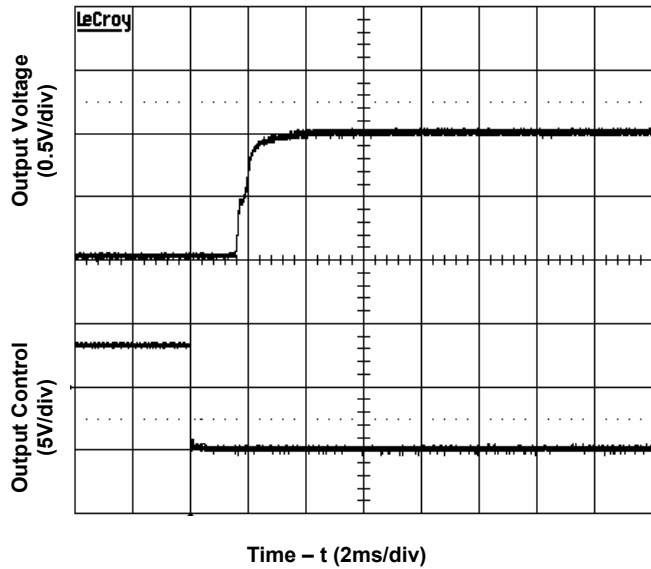

Figure 3. Start-Up from Enable Control  
Input voltage 48V, Output current 0A

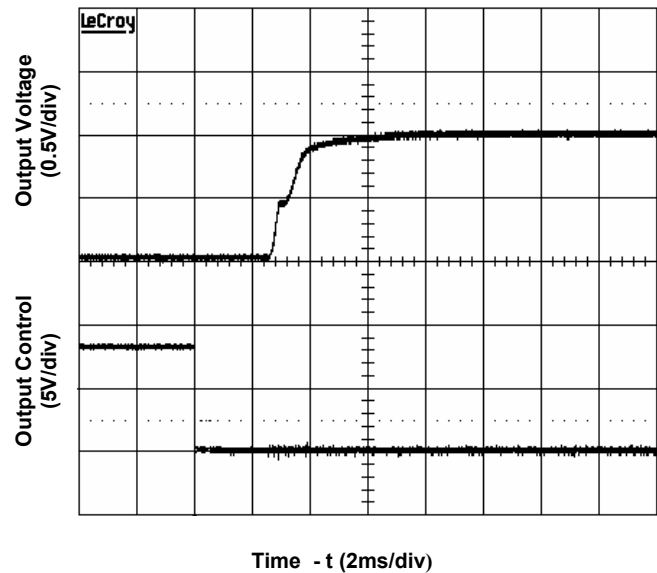
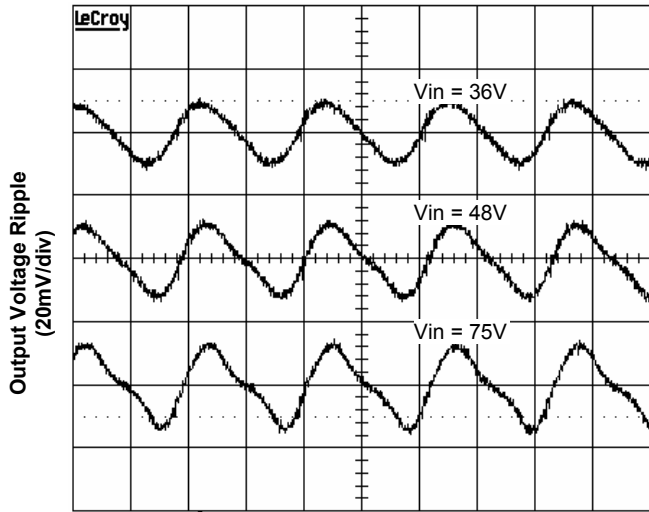
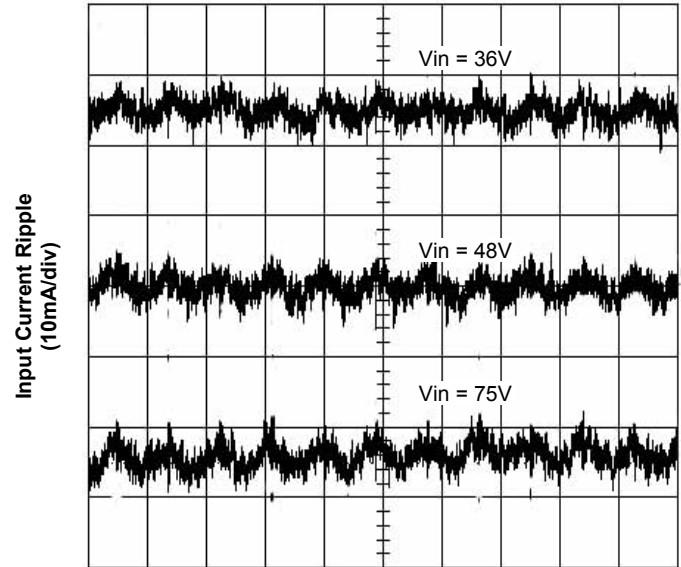

Figure 4. Start-Up from Enable Control  
Input voltage 48V, Output current 30A



Time - t (2µs/div)  
Figure 5. Output Ripple Voltage at 30A Load



Time - t (5µs/div)  
Figure 6. Input Reflected Ripple Current at 30A Load

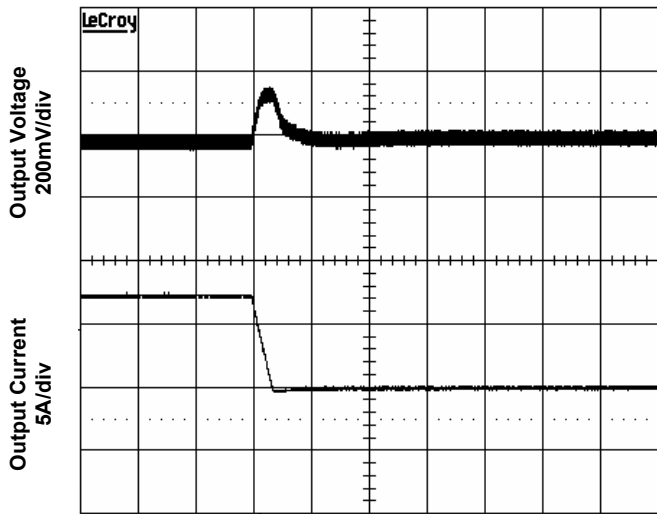

Time - t (200µs/div)  
Figure 7. Transient Load Response

Top: Output voltage deviation  
Bottom: Load current step (-25% full load)  
Test Cond.: Output current 15A (50% full load), Input voltage 48V, Slew rate 0.1A/µs

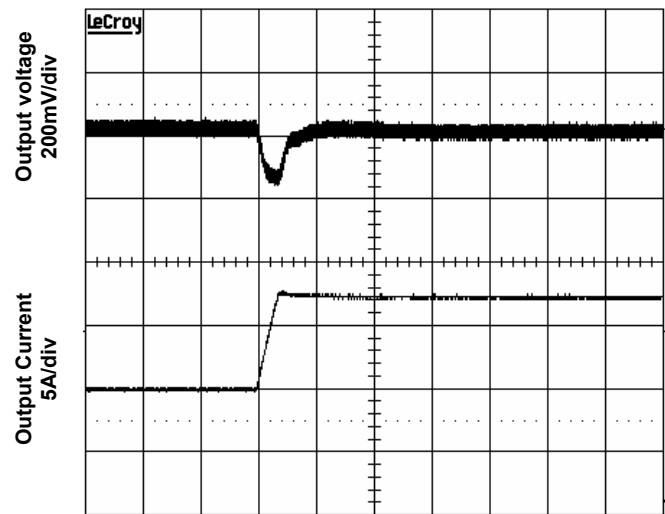

Time - t (200µs/div)  
Figure 8. Transient Load Response

Top: Output voltage deviation  
Bottom: Load current step (+25% full load)  
Test Cond.: Output current 15A (50% full load), Input voltage 48V, Slew rate 0.1A/µs

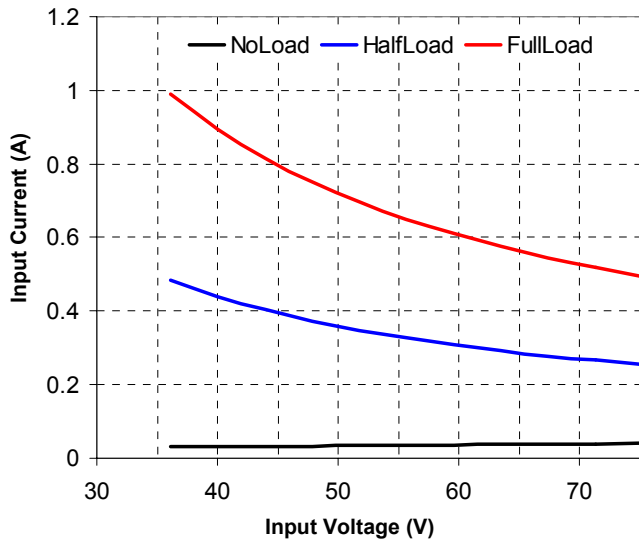

**Figure 9. Input Characteristics**

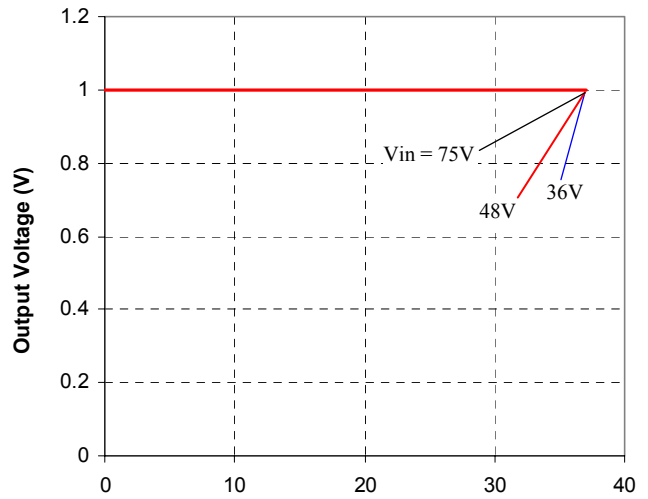

**Figure 10. Output Characteristics**

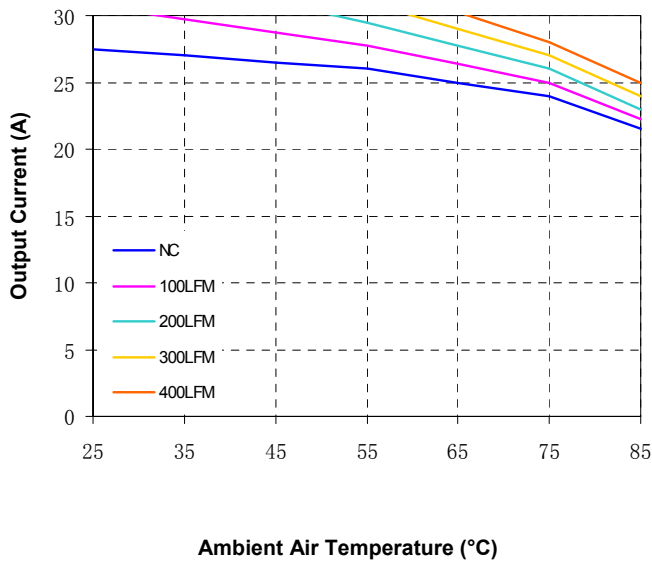

**Figure 11. Current Derating Curve for Airflow Direction 3**  
(Ref. Fig. 12 for Airflow Direction; Vin = 48V  
open frame unit using socket interface)

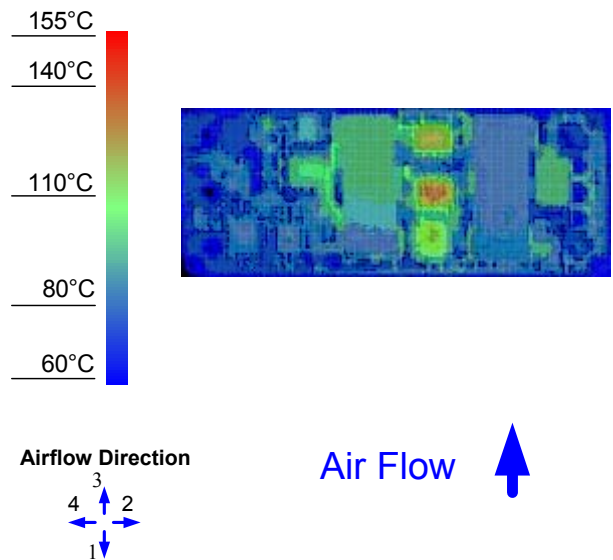

**Figure 12. Thermal Image for Airflow Direction 3**  
(27.5A output, 55°C ambient, 200 LFM, Vin = 48V  
open frame unit using socket interface)

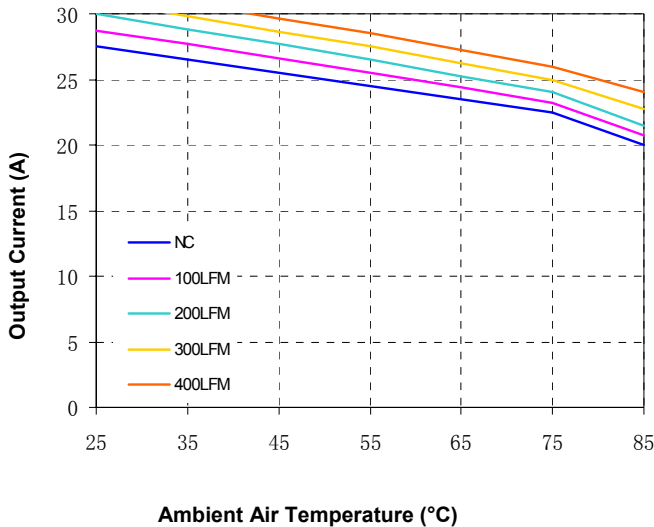

Figure 13. Current Derating Curve for Airflow Direction 2 (Ref. Fig. 14 for Airflow Direction; Vin = 48V open frame unit using socket interface)

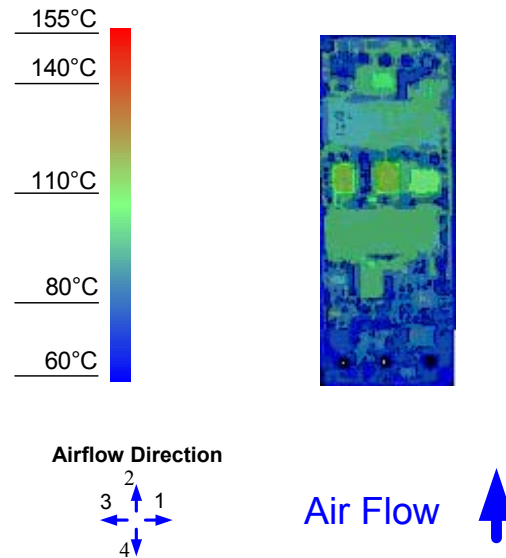

Figure 14. Thermal Image for Airflow Direction 2 (24.8A output, 55°C ambient, 200 LFM, Vin = 48V open frame unit using solder interface)

## Feature Descriptions

### Remote ON/OFF

The converter can be turned on and off by changing the voltage between the ON/OFF pin and Vin(-). The ERS Series of converters is available with factory selectable positive logic and negative logic.

For the negative control logic, the converter is ON when the ON/OFF pin is at a logic low level and OFF when the ON/OFF pin is at a logic high level. For the positive control logic, the converter is ON when the ON/OFF pin is at a logic high level and OFF when the ON/OFF pin is at a logic low level.

With the internal pull-up circuitry, a simple external switch between the ON/OFF pin and Vin(-) can control the converter. A few example circuits for controlling the ON/OFF pin are shown in Fig. 15, 16 and 17.

The logic low level is from 0V to 1.0V and the maximum switch current during logic low is 1mA.

The external switch must be capable of maintaining a logic-low level while sinking up to this current. The maximum voltage at the ON/OFF pin generated by the converter internal circuitry is less than 15V. The maximum allowable leakage current is 50µA.

### Remote SENSE

The remote SENSE pins are used to sense the voltage at the load point to accurately regulate the load voltage and eliminate the impact of the voltage drop in the power distribution path.

SENSE(+) and SENSE(-) pins should be connected to the point where regulation is desired. The voltage between the SENSE pins and the output pins must not exceed 0.5V:

$$[V_{out(+)} - V_{out(-)}] - [SENSE(+)-SENSE(-)] < 0.5V$$

When remote sense is not used, the SENSE pins should be connected to their corresponding output terminals (positive and negative). If the SENSE pins are left floating, the converter will deliver an output voltage slightly higher than its specified typical output voltage. Since the OVP (output over-voltage

protection) circuit senses the voltage across the output pins (Pin 8 and Pin 4), the total voltage rise should not exceed the minimum OVP setpoint given in the Specifications table.

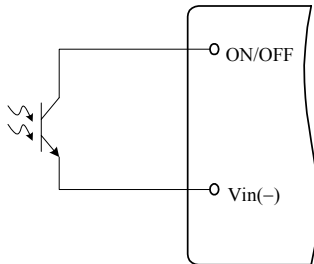

Fig. 15 Opto Coupler Enable Circuit

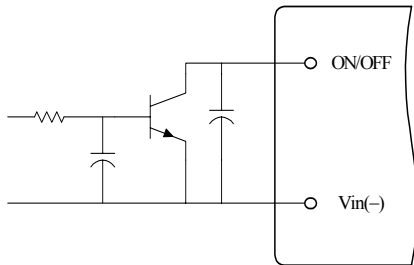

Fig. 16 Open Collector Enable Circuit

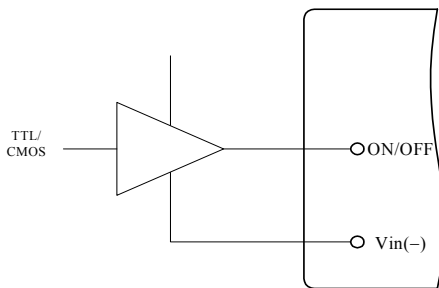

Fig. 17 Direct Logic Drive

### Output Voltage Adjustment (Trim)

The trim pin allows the user to adjust the output voltage set point. To increase the output voltage, an external resistor is connected between the TRIM pin and SENSE(+). To decrease the output voltage, an external resistor is connected between the TRIM pin and SENSE(-). The output voltage trim range is 80% to 110% of its specified nominal output voltage. The circuit configuration for trim down operation is shown in Fig. 20.

To decrease the output voltage, the value of the external resistor should be

$$R_{down} = \left( \frac{511}{\Delta} - 10.22 \right) (k\Omega)$$

Where

$$\Delta = \left( \frac{|V_{nom} - V_{adj}|}{V_{nom}} \right) \times 100$$

and

$V_{nom}$  = Nominal Voltage

$V_{adj}$  = Adjusted Voltage

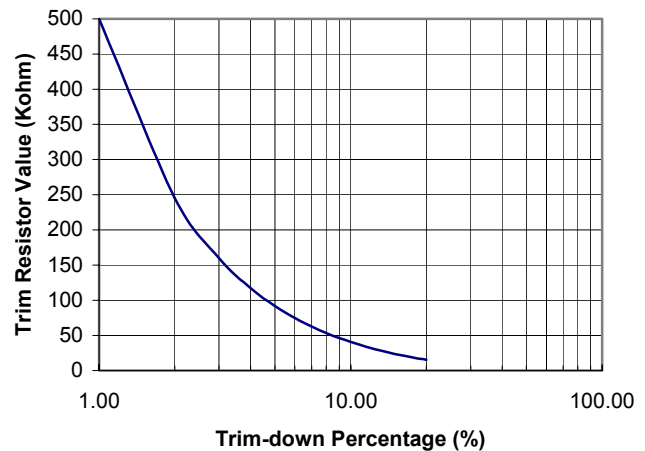

Fig. 18 Trim-Down Resistor Selection

The circuit configuration for trim up operation is shown in Fig. 21.

To increase the output voltage, the value of the resistor should be

$$R_{up} = \left( \frac{5.11V_o(100 + \Delta)}{0.6\Delta} - \frac{511}{\Delta} - 10.22 \right) (k\Omega)$$

Where

$V_o$  = Nominal Output Voltage

As the output voltage at the converter output terminals are higher than the specified nominal level when using the trim up and/or remote sense functions, it is important not to exceed the maximum power rating of the converter as given in the Specifications table.

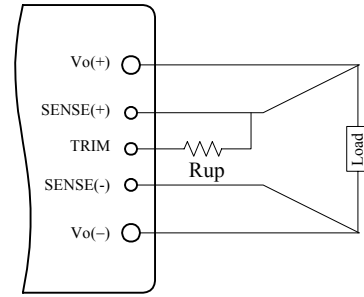

**Fig. 21** Circuit to Increase Output Voltage

### Input Under-Voltage Lockout

This feature prevents the converter from turning on until the input voltage reaches 34V typical, and shuts down the converter if the input voltage falls below 32V typical. The 2V hysteresis prevents oscillations.

### Output Over-Current Protection

As a standard feature, the converter will latch off when the load current exceeds the current limit. The converter can be restarted by toggling the ON/OFF switch or recycling the input voltage. With the auto-restart option, the converter will operate in a hiccup mode (repeatedly try to restart) until the over-current condition is cleared.

### Output Over-Voltage Protection

If the voltage across the output pins exceeds the output voltage protection threshold as given in the Specifications table, the converter will shut down to protect the converter and the load.

As a standard feature, the converter will shut down and latch off when this fault occurs. The converter can be restarted by toggling the ON/OFF switch or recycling the input voltage. With the auto-restart option, the converter will operate in a hiccup mode until the over-voltage cause is cleared.

### Thermal Shutdown

As a standard feature, the converter will shut down and latch off if an over-temperature condition is detected. The converter has a temperature sensor

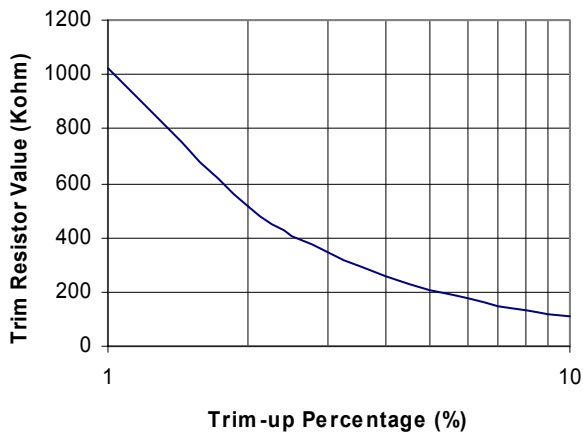

**Fig. 19** Trim-Up Resistor Selection

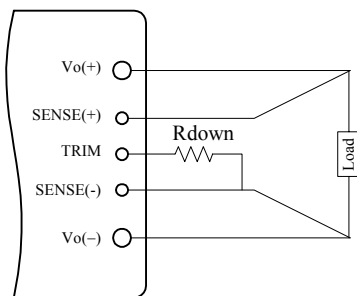

**Fig. 20** Circuit to Decrease Output Voltage

located at a carefully selected position in the converter circuit board, which represents the thermal condition of key components of the converter.

The thermal shutdown circuit is designed to turn the converter off when the temperature at the sensor reaches 120°C. The module can be restarted by toggling the ON/OFF switch or recycling the input voltage. With the auto-restart option, the converter will resume operation after the converter cools down.

## Design Considerations

### Input Source Impedance

As with any DC/DC converter, the stability of the ERS converters may be compromised if the source impedance is too high or inductive. It's desirable to keep the input source ac-impedance as low as possible. Although the converters are designed to be stable without an additional input capacitor for typical source impedance, it is recommended to use at least a 33 - 100  $\mu$ F low ESR electrolytic capacitor at the input of the converter to reduce the potential impact of the source impedance. This electrolytic capacitor should have sufficient RMS current rating over the operating temperature range.

## Safety Considerations

The ERS Series of converters are designed in accordance with EN 60950 Safety of Information Technology Equipment Including Electrical Equipment. The converters are recognized by UL in both USA and Canada to meet 1500V Basic Insulation requirements in UL 60950, Safety of Information Technology Equipment and applicable Canadian Safety Requirement, and ULc 60950. Flammability ratings of the PWB and plastic components in the converter meet 94V-0.

To protect the converter and the system, an input line fuse is highly recommended on the un-grounded input end.

A maximum rating of 10A normal-blow fuse should be connected at the un-grounded input lead of each ERS converter.

## Thermal Considerations

The ERS Series of converters can operate in various thermal environments. Due to the high efficiency and optimal heat distribution, these converters exhibit excellent thermal performance. Most heat generating components are mounted on the topside of the module, so the heat can be easily removed by conduction, convection and radiation. Proper cooling can be verified by monitoring the temperature of key components. Figure 22 shows a recommended temperature monitoring point. The temperature at this location should not continuously exceed 120 °C.

The maximum allowable output power of any power converter is usually determined by the electrical design and the maximum operating temperature of its components. The ERS Series of converters has been tested comprehensively under various conditions to generate the derating curves with the consideration for long term reliability.



**Figure 22.** Temperature Monitoring Location

The thermal derating curves are highly influenced by the test conditions. One of the critical variables is the interface method between the converter and the test fixture board. There is no standard method in the industry for the derating tests. Some suppliers use sockets to plug in the converter, while others solder the converter into the fixture board. It should be noticed that these two methods produce significantly different results for a given converter. When the converter is soldered into the fixture board, the thermal performance of the converter is significantly improved compared to using sockets due to the reduction of the contact loss and the thermal impedance from the pin to the fixture board. Other factors affecting the results include the board spacing, construction (especially copper weight, holes and openings) of the fixture board and the spacing board, temperature measurement method and



ambient temperature measurement point. Thermal derating curves in this datasheet are obtained using a PWB fixture board and a PWB spacing board with no opening, a board-to-board spacing of 1", and thermal couplers to monitor all temperatures. For thermal considerations specific to your application environment, please contact NetPower's technical support team for further advice.

### **Heat Transfer without a Baseplate**

As with other single-board DC/DC converter designs, convection heat transfer is the primary cooling means for converters without a baseplate. Therefore, airflow speed should be checked carefully for the intended operating environment. Increasing the airflow over the converter enhances the heat transfer via convection.

Note that the natural convection condition was measured at 0.05 m/s to 0.15 m/s (10ft./min. to 30 ft./min).

### **Heat Transfer with a Baseplate**

The ERS Series of converters has the heat transfer options of using a baseplate for enhanced thermal performance.

The nominal height of the converter with the baseplate option is 0.50".

## **EMC Considerations**

The ERS Series of converters meet EN55022 class B and FCC part 15J requirements with an external filter.

The EMC performance of the converter is related to the layout and filtering design of the customer board. As with other switching-mode power supplies, careful layout and adequate filtering around the module are important to confine noise generated by the switching in the converter and to optimize system EMC performance.

For assistance with designing for EMC compliance, please contact NetPower's technical support team at [support@netpowercorp.com](mailto:support@netpowercorp.com).

## Mechanical Diagrams

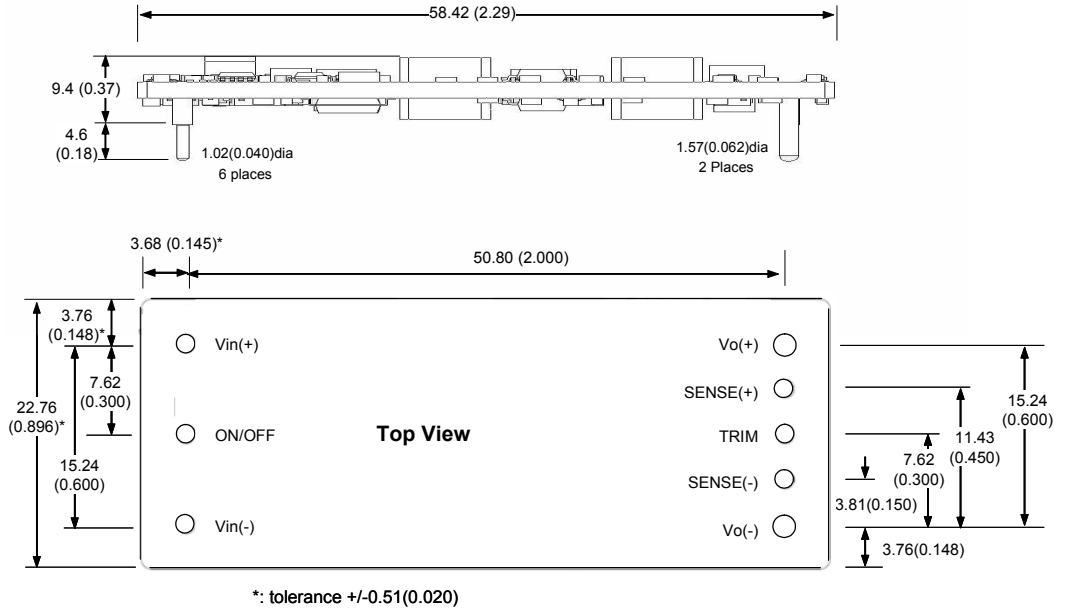

Side View

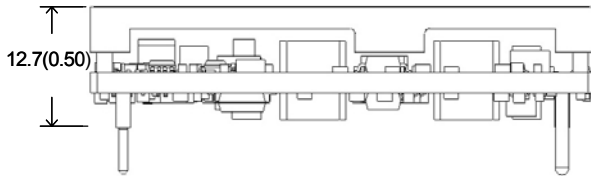

Top View

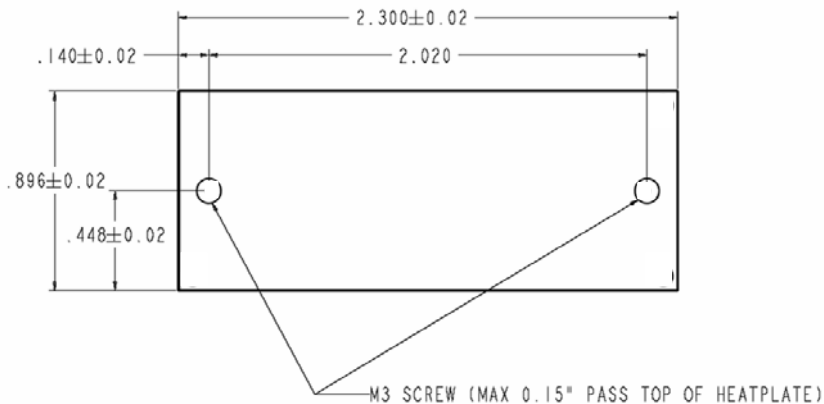

## Notes

- 1) All dimensions in mm (inches)  
Tolerances: .x ± .5 (.xx ± 0.02)  
.xx ± .25 (.xxx ± 0.010)
- 2) Input and control pins are 1.02mm (0.040") dia. with 1.68mm (0.066") dia. standoff shoulders.
- 3) Output pins are 1.57 mm (0.062") dia with 2.49mm (0.098") dia. standoff shoulders.
- 4) All pins are coated with 90%/10% solder finish or Matte Tin with Nickel underplating. (Depending on lead-free requirements).
- 5) Weight: 25.5 g (open frame)
- 6) Workmanship: Meet or exceeds IPC-A-610 Class II
- 7) Torque applied on screws should not exceed 6in-lb(0.7 Nm).
- 8) Baseplate flatness tolerance is 0.10mm (0.004") TIR for surface
- 9) If M3 screws are used to attach heatsink to the baseplate, the screw length from the top surface of baseplate going down should not exceed 3.8 mm (0.15 in) max .

Figure 20. Converter with optional baseplate



## Part Numbering System

ERS	4	010	N	030	R	0	5	
Series Name	Nominal Input Voltage	Nominal Output Voltage	Enabling Logic	Rated Output Current	Pin Length	Electrical Options	Mechanical Options	
							Leaded (RoHS 5)	Lead-free (RoHS 6)
ERS	4: 48V 2: 24V	Unit: 0.1V For example: 033 = 3.3V	P: positive N: negative	Unit: Amps For example: 030 = 30A	R: 0.180" N: 0.145" K: 0.110"	0: Default 2: auto restart	0: Open Frame 1: Baseplate	5: Open Frame 6: Baseplate

Part Numbering Example: **ERS4010N030N26**

Denotes an eighth brick module with 48V nominal input (36V - 75V), 1.0Vout, negative remote control logic, 30Aout, 0.145" pin length, auto-restart feature, ROHS compliant with a baseplate.

### For more information, please contact:

 **NetPower** Technologies, Inc.  
Toll Free: 866-NETPOWER (638-7693)  
Phone: 972-560-0500  
Fax: 972-560-0210  
E-mail: [sales@netpowercorp.com](mailto:sales@netpowercorp.com)  
Address: 1680 Prospect #200, Richardson, TX 7508

### Warranty

NetPower offers a two (2) year limited warranty. Complete warranty information is listed on our web site or is available upon request. Information furnished by NetPower is believed to be accurate and reliable. However, no responsibility is assumed by NetPower for its use, nor for any infringements of patents or other rights of third parties which may result from its use. No license is granted by implication or otherwise under any patent or patent rights of NetPower.